

TECHNICAL MANUAL

Split system KANAMI Series
on/off, R32

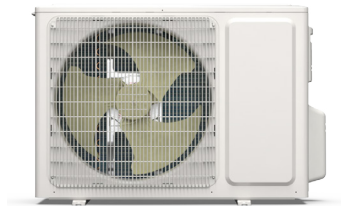
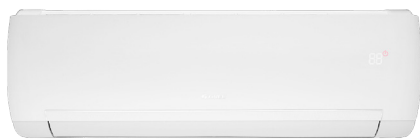

KSGA21HFRN1 / KSRA21HFRN1

KSGA26HFRN1 / KSRA26HFRN1

KSGA35HFRN1 / KSRA35HFRN1

KSGA53HFRN1 / KSRA53HFRN1

KSGA70HFRN1 / KSRA70HFRN1

| Table of Contents | Page |
|---|-----------|
| Specifications | 3 |
| 1. Model Reference | 4 |
| 2. General Specifications | 5 |
| 3. Dimensional Drawings..... | 9 |
| 4. Centre of Gravity | 14 |
| 5. Air Velocity and Temperature Distributions | 16 |
| 6. Electrical Wiring Diagrams..... | 26 |
| 7. Refrigerant Cycle Diagrams..... | 29 |
| 8. Capacity Tables | 32 |
| 9. Noise Criterion Curves | 42 |
| 10. Electrical Characteristics | 46 |
| Product Features | 47 |
| 1. Operation Modes and Functions | 48 |
| 2. Remote Controller Functions | 52 |
| Installation | 63 |
| Accessoires..... | 64 |
| 1. Installation Overview-Indoor Unit..... | 65 |
| 2. Location Selection..... | 66 |
| 3. Indoor Unit Installation | 67 |
| 4. Outdoor Unit Installation (Side Discharge Unit)..... | 72 |
| 5. Refrigerant Pipe Installation | 73 |
| 6. Vacuum Drying and Leakage Checking | 75 |
| 7. Additional Refrigerant Charge | 76 |
| 8. Electrical and Gas Leak Checks | 76 |
| 9. Test Operation..... | 77 |

Specifications

| Contents | Page |
|---|------|
| 1. Model Reference | 4 |
| 2. General Specifications | 5 |
| 3. Dimensional Drawings..... | 9 |
| 4. Centre of Gravity | 14 |
| 5. Air Velocity and Temperature Distributions | 16 |
| 6. Electrical Wiring Diagrams..... | 26 |
| 7. Refrigerant Cycle Diagrams..... | 29 |
| 8. Capacity Tables | 32 |
| 9. Noise Criterion Curves | 42 |
| 10. Electrical Characteristics | 46 |

1. Model Reference

Refer to the following table to determine the specific indoor and outdoor unit model number of your purchased equipment.

| Indoor Unit Model | Outdoor Unit Model | Capacity (kW) | Power Supply |
|-------------------|--------------------|---------------|----------------------------|
| KSGA21HFRN1 | KSRA21HFRN1 | 2.34 | 220-240V~, 50Hz, 1Phase |
| KSGA26HFRN1 | KSRA26HFRN1 | 2.64 | |
| KSGA35HFRN1 | KSRA35HFRN1 | 3.52 | |
| KSGA53HFRN1 | KSRA53HFRN1 | 5.28 | |
| KSGA70HFRN1 | KSRA70HFRN1 | 7.03 | |

2. General Specifications

| | | | | | |
|--|------------------------------|------------------------|--|--|----------------------------------|
| Indoor Model | | | KSGA21HFRN1 | KSGA26HFRN1 | KSGA35HFRN1 |
| Outdoor Model | | | KSRA21HFRN1 | KSRA26HFRN1 | KSRA35HFRN1 |
| Power supply | | V- Ph-Hz | 220~240-1-50 | 220~240-1-50 | 220~240-1-50 |
| Cooling (Standard conditions) | Capacity | kW | 2,34 | 2,64 | 3,52 |
| | Input | W | 730 | 821 | 1095 |
| | Current | A | 3.74 | 3.6 | 4.76 |
| | EER | W/W | 3.21 | 3.21 | 3.21 |
| Heating (Standard conditions) | Capacity | kW | 2,34 | 2,78 | 3,66 |
| | Input | W | 650 | 771 | 1015 |
| | Current | A | 3.14 | 3.4 | 4.41 |
| | COP | W/W | 3.61 | 3.61 | 3.61 |
| Rated Power Input | | W | 1300 | 1300 | 1600 |
| Rated Current | | A | 7 | 7.5 | 9.5 |
| Starting current | | A | 18 | 18.0 | 25 |
| Compressor | Model | | KSM89V21VDZ3 | KSM89V21VDZ3 | KSM125V2VDZ |
| | Type | | ROTARY | ROTARY | ROTARY |
| | Brand | | GMCC | GMCC | GMCC |
| | Capacity | W | 2680/2715 | 2680/2715 | 3770/3805 |
| | Input | W | 670/700 | 670/700 | 910/960 |
| | Rated current(RLA) | A | 3.05 | 3.05 | 4.20/4.10 |
| | Locked rotor Amp(LRA) | A | 18 | 18 | 25 |
| | Thermal protector | | HPA-318L/UP3-A0L | HPA-318L/UP3-A0L | / |
| | Thermal protector position | | INTERNAL | INTERNAL | INTERNAL |
| | Capacitor | uF | 25 | 25 | 35 |
| Refrigerant oil/oil charge | ml | ESTER OIL VG68 ·270±15 | ESTER OIL VG68 ·270±15 | VG68 300 ±15 | |
| Indoor fan motor | Model | | YKFG-20-4-5-21 | YKFG-20-4-5-21 | YKFG-20-4-5-21 |
| | Input | W | 44 | 44 | 44 |
| | Output | W | 20 | 20 | 20 |
| | Insulation class | / | E | E | E |
| | Waterproofing class | / | IPX0 | IPX0 | IPX0 |
| | Capacitor | uF | 1.5 | 1.5 | 1.5 |
| | Capacitor class | / | S3 | S3 | S3 |
| | Speed(Hi/Mi/Lo) | r/min | 1100/950/800 | 1170/1050/800 | 1150/1000/800 |
| Indoor coil | Number of rows | | 2 | 2 | 2 |
| | Tube pitch(a)x row pitch(b) | mm | 21x13.37 | 21x13.37 | 21x13.37 |
| | Fin spacing | mm | 1.2/1.3 | 1.2/1.3 | 1.3 |
| | Fin type (code) | | Hydrophilic aluminium | Hydrophilic aluminium | Hydrophilic aluminium |
| | Tube outside dia.and type | mm | Ø7,innergroove tube | Ø7,innergroove tube | Ø7,innergroove tube |
| | Coil length x height x width | mm | 525x84x- 13.37+525x105x- 26.74+525x105x26.74 | 525x84x- 13.37+525x105x- 26.74+525x105x26.74 | 605x210x- 26.74+605x105x26.74 |
| | Number of circuits | | 2 | 2 | 2 |
| Indoor air flow (Hi/Mi/Lo) | | m ³ /h | 470/390/320 | 530/460/330 | 560/480/360 |
| Indoor sound pressure level (Hi/Mi/Lo) | | dB(A) | 39/34.5/26.5 | 41.0/37.0/27.0 | 40.5/36/27.5 |
| Indoor unit | Dimension(WxDxH) | mm | 729x200x292 | 729x200x292 | 802x200x295 |
| | Packing (WxDxH) | mm | 790x270x375 | 790x270x375 | 875x285x380 |
| | Net/Gross weight | kg | 8.2/10.5 | 8.2/10.5 | 9.0/11.5 |
| Outdoor fan motor | Model | | YKT-21-6-12L | YKT-24-6-231L | YKT-24-6-231L |
| | Input | W | 54.6 | 63.5 | 63.5 |
| | Output | W | 21 | 24 | 24 |
| | Insulation class | / | B | B | B |
| | Waterproofing class | / | IP24 | IPX4 | IPX4 |
| | Capacitor | uF | 1.5 | 2.0 | 2.0 |
| | Capacitor class | / | P2 | S3 | S3 |
| Speed | r/min | 870 | 820 | 820 | |

| | | | | | |
|------------------------------|------------------------------|-------------------|-----------------------|-----------------------|------------------------|
| Indoor Model | | | KSGA21HFRN1 | KSGA26HFRN1 | KSGA35HFRN1 |
| Outdoor Model | | | KSRA21HFRN1 | KSRA26HFRN1 | KSRA35HFRN1 |
| Outdoor coil | Number of rows | | 1 | 1 | 1 |
| | Tube pitch(a)x row pitch(b) | mm | 21x22 | 21x13.37 | 21x13.37 |
| | Fin spacing | mm | 1.3 | 1.4 | 1.4 |
| | Fin type (code) | | Hydrophilic aluminum | Hydrophilic aluminum | Hydrophilic aluminum |
| | Tube outside dia.and type | mm | Ø7,innergroove tube | Ø7,innergroove tube | Ø7,Inner groove tube |
| | Coil length x height x width | mm | 600x420x22 | 750x462x13.37 | 750x462x13.37 |
| | Number of circuits | | 2 | 2 | 2 |
| Outdoor air flow | | m ³ /h | 1300 | 1800 | 1800 |
| Outdoor sound pressure level | | dB(A) | 52 | 53.0 | 55 |
| Outdoor unit | Dimension(WxDxH) | mm | 668x252x469 | 720x270x495 | 720x270x495 |
| | Packing (WxDxH) | mm | 765x270x525 | 835x300x540 | 835x300x540 |
| | Net/Gross weight | kg | 22.7/24.3 | 24.7/26.6 | 25.6/27.4 |
| Refrigerant type | | kg | R32/0.46 | R32/0.56 | R32/0.53 |
| Design pressure | | MPa | 4.3/1.7 | 4.3/1.7 | 4.3/1.7 |
| Refrigerant piping | Liquid side/ Gas side | mm(inch) | Ø6.35/Ø9.52(1/4"3/8") | Ø6.35/Ø9.52(1/4"3/8") | Ø6.35/Ø12.7(1/4"/1/2") |
| | Max. refrigerant pipe length | m | 20 | 20 | 20 |
| | Max. difference in level | m | 8 | 8 | 8 |
| Connection wiring | | | 1.5x3/0.75x2 | 1.5x3/0.75x2 | 1.5x3/0.75x2 |
| Plug type | | | 1.5x3/VDE | 1.5x3/VDE | 1.5x3/VDE |
| Thermostat type | | | Remote Control | Remote Control | Remote Control |
| Operation temperature | | | 16-30 | 16-30 | 16-30 |
| Ambient temperature | Indoor(cooling/ heating) | °C | 16-32/0-30 | 16-32/0-30 | 16-32/0-30 |
| | Outdoor(cooling/heating) | °C | 18-43/-7-24 | 18-43/-7-24 | 18-43/-7-24 |
| Qty'per 20' /40' /40'HQ | | | 168/342/387 | 138/282/312 | 125/256/284 |

Notes:

1) Capacities are based on the following conditions:

Cooling: - Indoor Temperature 27°C(80.6°F) DB / 19 °C(66.2°F) WB

Heating: - Indoor Temperature 20°C(68°F) DB / 15°C(59°F) WB

-Outdoor Temperature 35 °C(95°F) DB / 24 °C(75.2°F) WB

-Outdoor Temperature 7°C(44.6°F) DB / 6°C(42.8°F) WB

-Interconnecting Piping Length 5m

- Interconnecting Piping Length 5 m

- Level Difference of Zero.

- Level Difference of Zero.

2) Capacities are Net Capacities.

3) Due to our policy of innovation some specifications may be changed without notification.

| | | | | |
|--|------------------------------|----------|-----------------------------|-----------------------------|
| Indoor Model | | | KSGA53HFRN1 | KSGA70HFRN1I |
| Outdoor Model | | | KSRA53HFRN1 | KSRA70HFRN1 |
| Power supply | | V- Ph-Hz | 220~240-1-50 | 220~240-1-50 |
| Cooling (Standard conditions) | Capacity | kW | 5,28 | 7,03 |
| | Input | W | 1643 | 2190 |
| | Current | A | 7.4 | 9.6 |
| | EER | W/W | 3.21 | 3.21 |
| Heating (Standard conditions) | Capacity | kW | 5,57 | 7,33 |
| | Input | W | 1542 | 2030 |
| | Current | A | 7.0 | 8.8 |
| | COP | W/W | 3.61 | 3.61 |
| Rated Power Input | | W | 2350 | 2900 |
| Rated Current | | A | 13 | 15.5 |
| Starting current | | A | 38 | 42 |
| Compressor | Model | | KSF190V1VETB | KSG240S1VKT |
| | Type | | ROTARY | ROTARY |
| | Brand | | GMCC | GMCC |
| | Capacity | W | 5835/5875±3% | 7200 |
| | Input | W | 1370/1470±3% | 1665±3% |
| | Rated current(RLA) | A | 6.40/6.30±3% | 7.3±3% |
| | Locked rotor Amp(LRA) | A | 38±10% | 42±10% |
| | Thermal protector | | UP3-A6/HPA-340 | HPA-441H |
| | Thermal protector position | | INTERNAL | INTERNAL |
| | Capacitor | uF | 45 | 60 |
| | Refrigerant oil/oil charge | ml | ESTER OIL VG74 410±15 | VG74 610±15 |
| Indoor fan motor | Model | | YKFG-28-4-3-14 | YKFG-45-4-22-13 |
| | Input | W | 71.0 | 77.0 |
| | Output | W | 28 | 45 |
| | Insulation class | / | E | B |
| | Waterproofing class | / | IPX0 | IPX0 |
| | Capacitor | uF | 1.5 | 3 |
| | Capacitor class | / | S3 | S3 |
| | Speed(Hi/Mi/Lo) | r/min | 1200/950/850 | 1200/1050/780 |
| Indoor coil | Number of rows | | 2 | 2 |
| | Tube pitch(a)x row pitch(b) | mm | 21x13.37 | 21x13.37 |
| | Fin spacing | mm | 1.2 | 1.3 |
| | Fin type (code) | | Hydrophilic aluminium | Hydrophilic aluminium |
| | Tube outside dia.and type | mm | Ø7,innergroove tube | Ø7,innergroove tube |
| | Coil length x height x width | mm | 750x210x26.74+750x126x26.74 | 820x210x26.74+820x126x26.74 |
| | Number of circuits | | 4 | 4 |
| Indoor air flow (Hi/Mi/Lo) | | m³/h | 822/619/543 | 1160/950/860 |
| Indoor sound pressure level (Hi/Mi/Lo) | | dB(A) | 44/38/33 | 48/42.5/33.5 |
| Indoor unit | Dimension(WxDxH) | mm | 971x228x321 | 1082x234x337 |
| | Packing (WxDxH) | mm | 1045x305x405 | 1155x415x315 |
| | Net/Gross weight | kg | 12.0/15.5 | 14.8/18.6 |
| Outdoor fan motor | Model | | YKT-24-6-236L | YKT-65-6-240L |
| | Input | W | 69.5 | 135 |
| | Output | W | 24 | 65 |
| | Insulation class | / | B | B |
| | Waterproofing class | / | IPX4 | IPX4 |
| | Capacitor | uF | 2.5 | 5 |
| | Capacitor class | / | S3 | S3 |
| Speed | r/min | 870 | 850 | |

| | | | | |
|------------------------------|------------------------------|-------------------|-----------------------------|------------------------|
| Indoor Model | | | KSGA53HFRN1 | KSGA70HFRN1I |
| Outdoor Model | | | KSRA53HFRN1 | KSRA70HFRN1 |
| Outdoor coil | Number of rows | | 2 | 1.6 |
| | Tube pitch(a)x row pitch(b) | mm | 21x13.37 | 21x13.37 |
| | Fin spacing | mm | 1.4 | 1.3 |
| | Fin type (code) | | Hydrophilic aluminum | Hydrophilic aluminum |
| | Tube outside dia.and type | mm | Ø7, innergroove tube | Ø7,Inner groove tube |
| | Coil length x height x width | mm | 755x504x13.37+735x504x13.37 | 900x609x26.74 |
| | Number of circuits | | 2 | 5 |
| Outdoor air flow | | m ³ /h | 2100 | 4200 |
| Outdoor sound pressure level | | dB(A) | 58.5 | 61.5 |
| Outdoor unit | Dimension(WxDxH) | mm | 765x303x555 | 890x342x673 |
| | Packing (WxDxH) | mm | 887x337x610 | 995x398x740 |
| | Net/Gross weight | kg | 34.5/37 | 47.9/50.9 |
| Refrigerant type | | kg | R32/1 | R32/1.3 |
| Design pressure | | MPa | 4.3/1.7 | 4.3/1.7 |
| Refrigerant piping | Liquid side/ Gas side | mm(inch) | Ø6.35/Ø12.7(1/4"/1/2") | Ø9.52/Ø15.9(3/8"/5/8") |
| | Max. refrigerant pipe length | m | 25 | 25 |
| | Max. difference in level | m | 10 | 10 |
| Connection wiring | | | 2.5x3/0.75x2 | 2.5x3/0.75x3 |
| Plug type | | | 2.5x3/no-plug | 2.5x3/no-plug |
| Thermostat type | | | Remote Control | Remote Control |
| Operation temperature | | | 16-30 | 16-30 |
| Ambient temperature | Indoor(cooling/ heating) | °C | 16-32/0-30 | 16-32/0-30 |
| | Outdoor(cooling/heating) | °C | 18-43/-7-24 | 18-43/-7-24 |
| Qty/per 20' /40' /40'HQ | | | 88/186/220 | 64/134/156 |

Notes:

1) Capacities are based on the following conditions:

Cooling: - Indoor Temperature 27°C(80.6°F) DB / 19 °C(66.2°F) WB

Heating: - Indoor Temperature 20°C(68°F) DB / 15°C(59°F) WB

-Outdoor Temperature 35 °C(95°F) DB / 24 °C(75.2°F) WB

-Outdoor Temperature 7°C(44.6°F) DB / 6°C(42.8°F) WB

-Interconnecting Piping Length 5m

- Interconnecting Piping Length 5 m

- Level Difference of Zero.

- Level Difference of Zero.

2) Capacities are Net Capacities.

3) Due to our policy of innovation some specifications may be changed without notification.

3. Dimensional Drawings

3.1 Indoor Unit

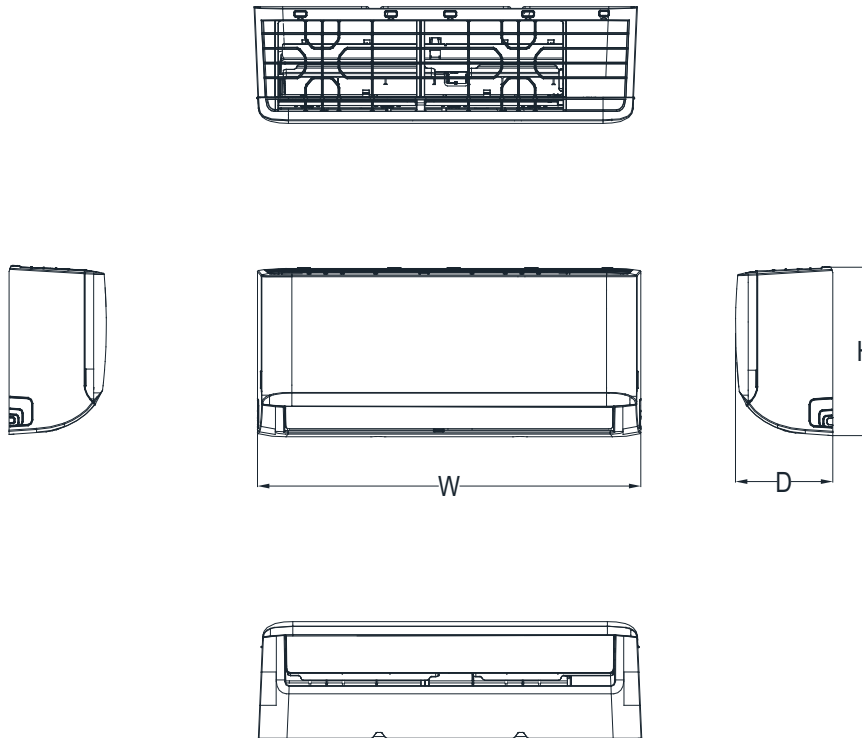

| Model | W(mm) | D(mm) | H(mm) |
|----------------|-------|-------|-------|
| KSGA21-26HFRN1 | 729 | 200 | 292 |
| KSGA35HFRN1 | 802 | 200 | 295 |
| KSGA53HFRN1 | 971 | 228 | 321 |
| KSGA70HFRN1 | 1082 | 234 | 337 |

3.2 Outdoor Unit

KSRA21HFRN1

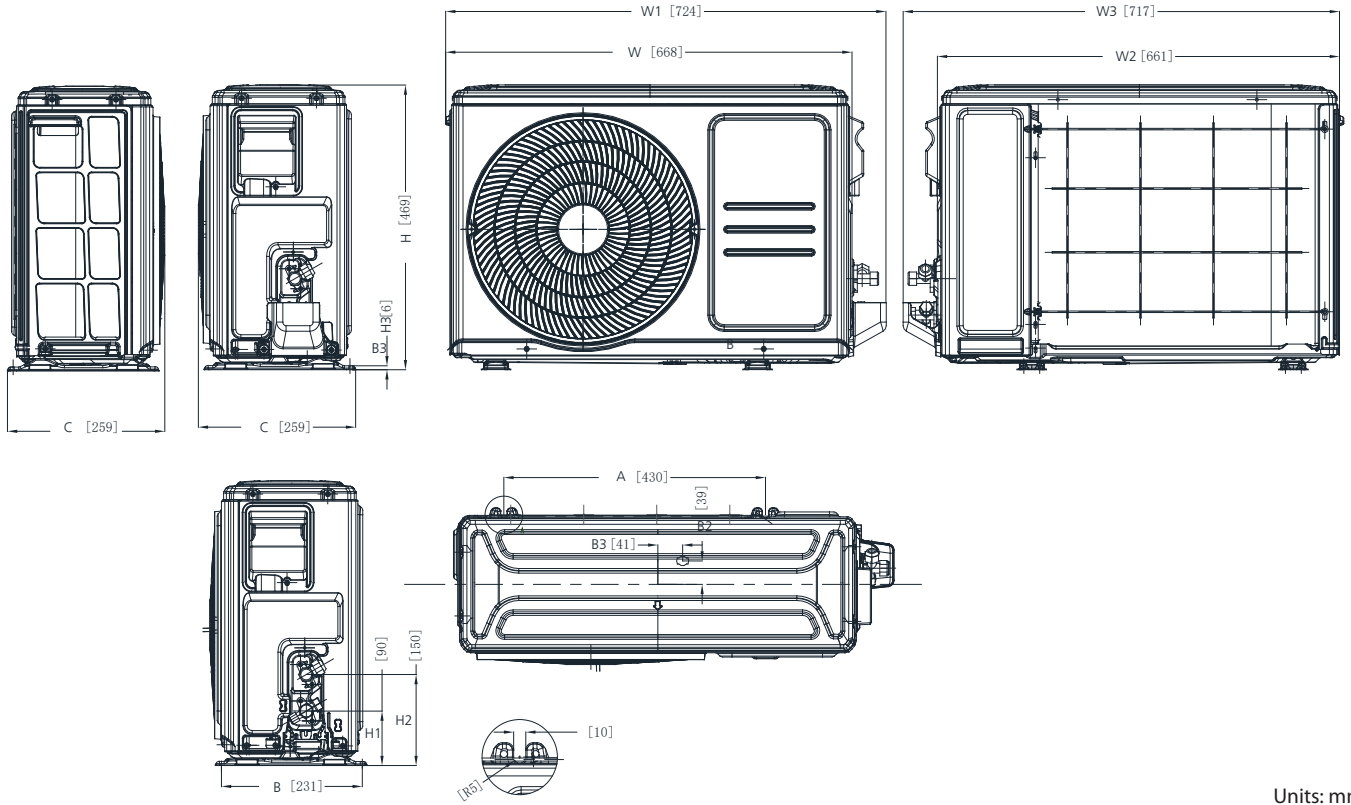

Units: mm

KSRA26HFRN1, KSRA35HFRN1

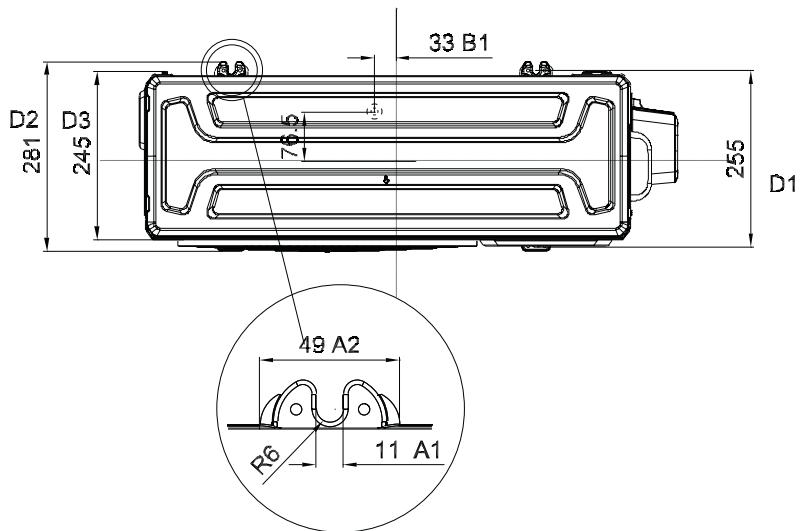
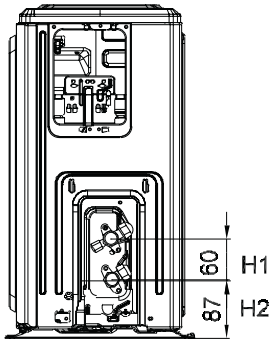
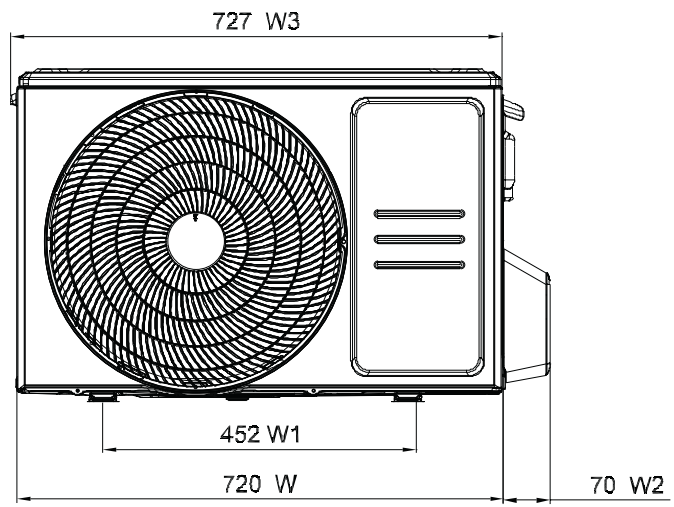
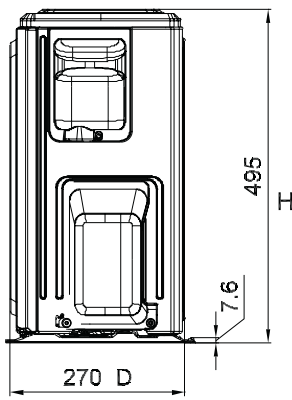

Units: mm

KSRA53HFRN1

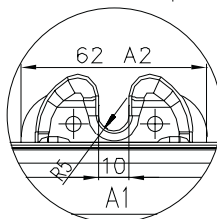
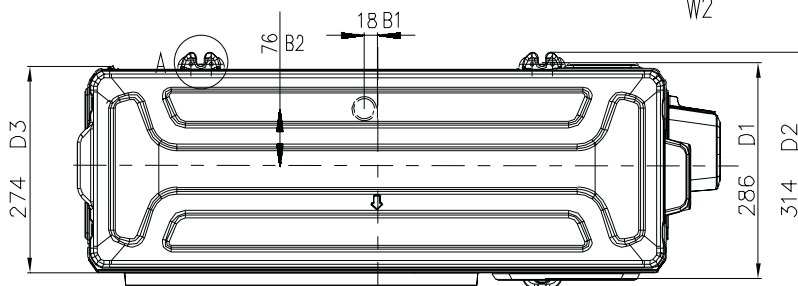
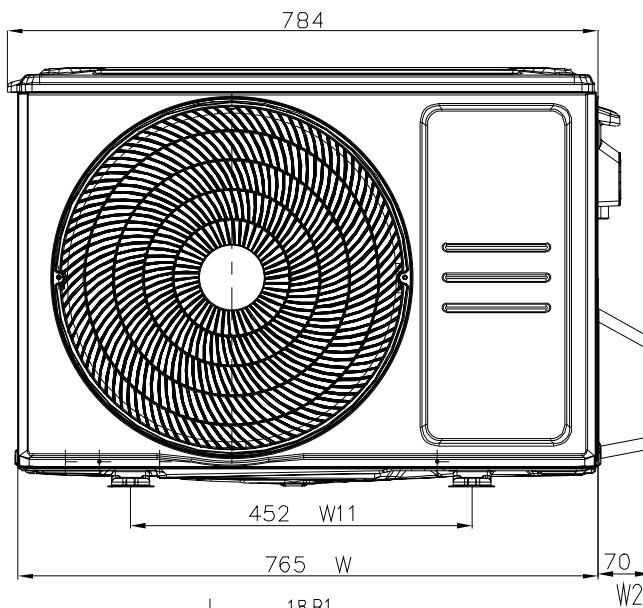
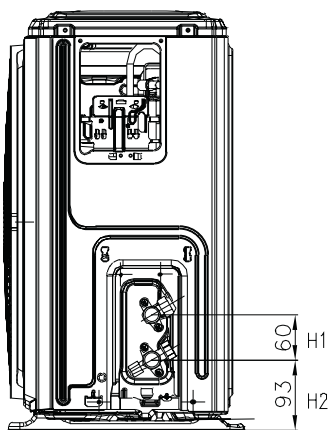
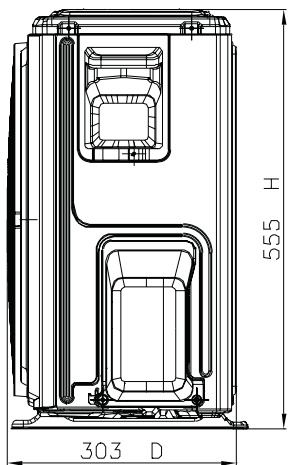

Units: mm

KSRA70HFRN1

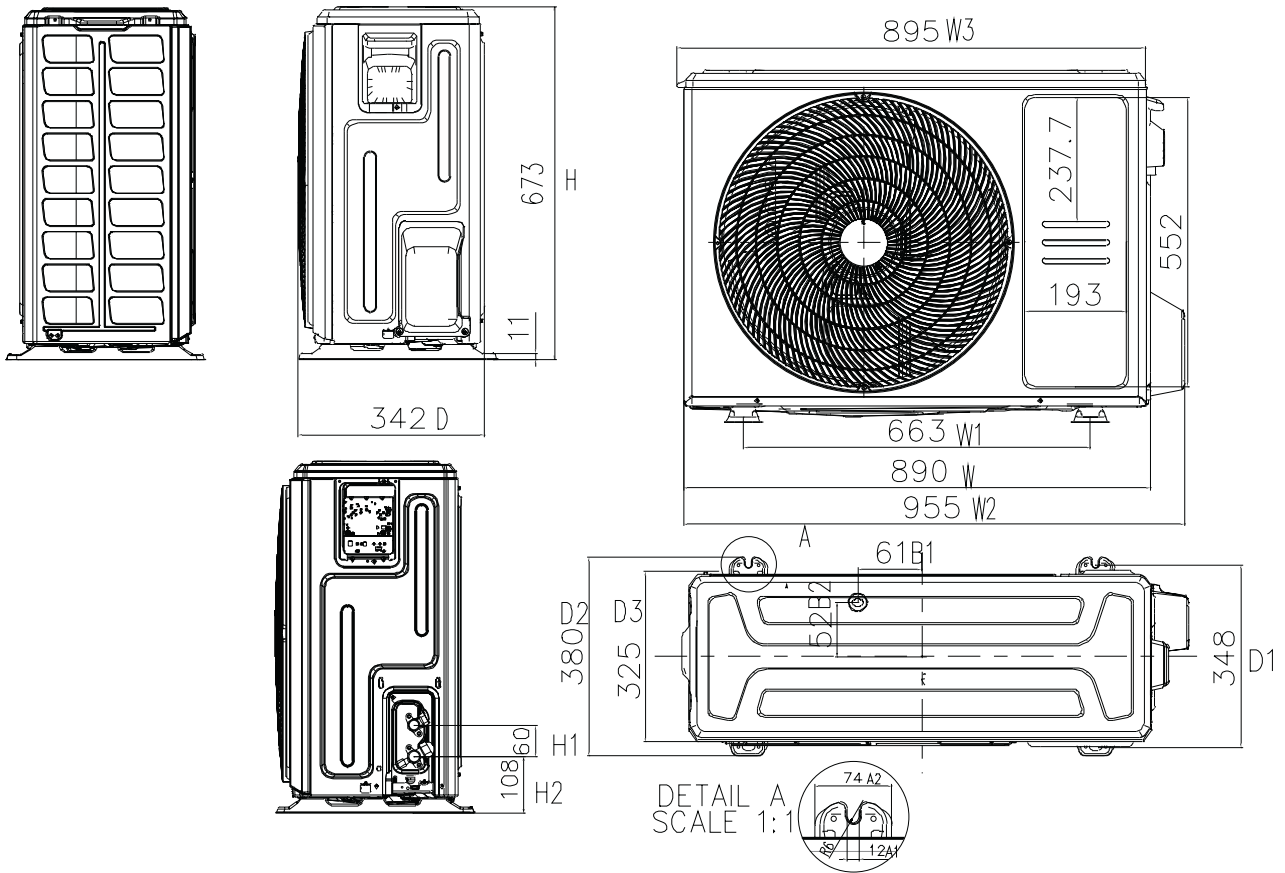

Units: mm

4. Centre of Gravity

KSRA21HFRN1

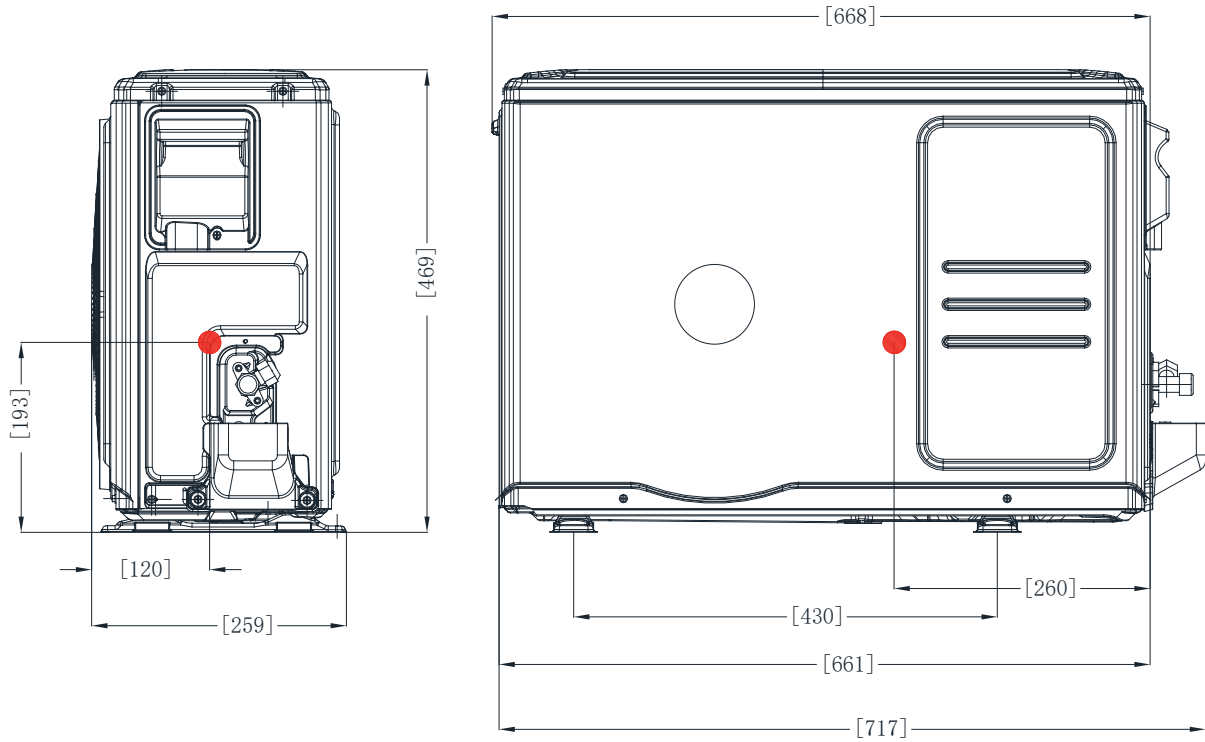

KSRA26HFRN1, KSRA35HFRN1

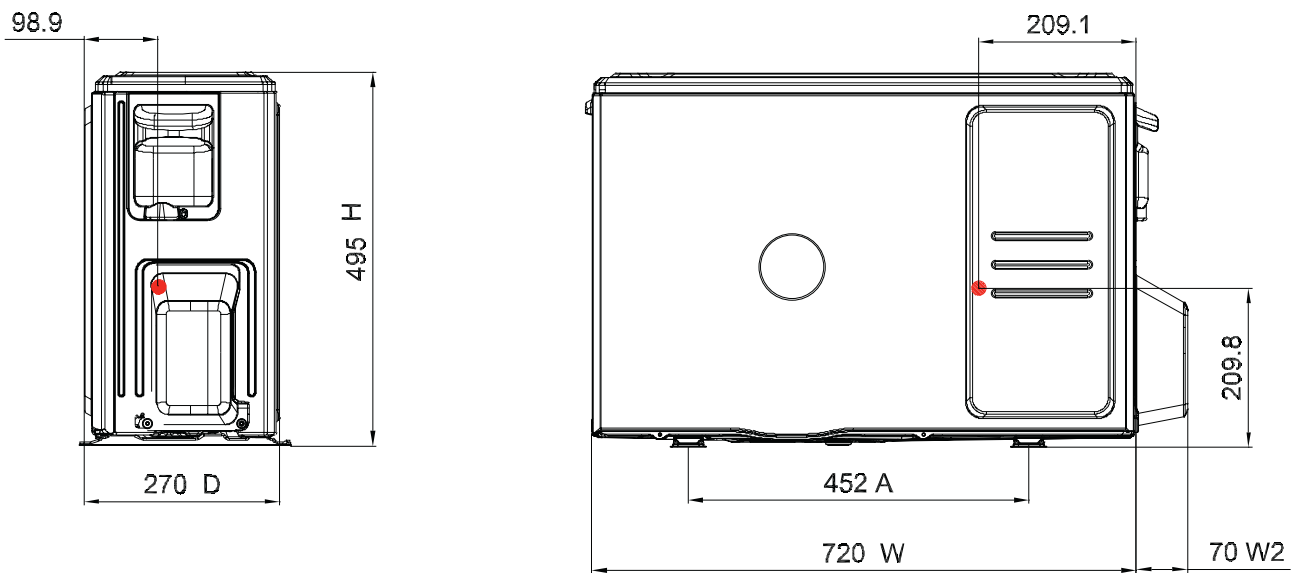

Units: mm

KSRA53HFRN1

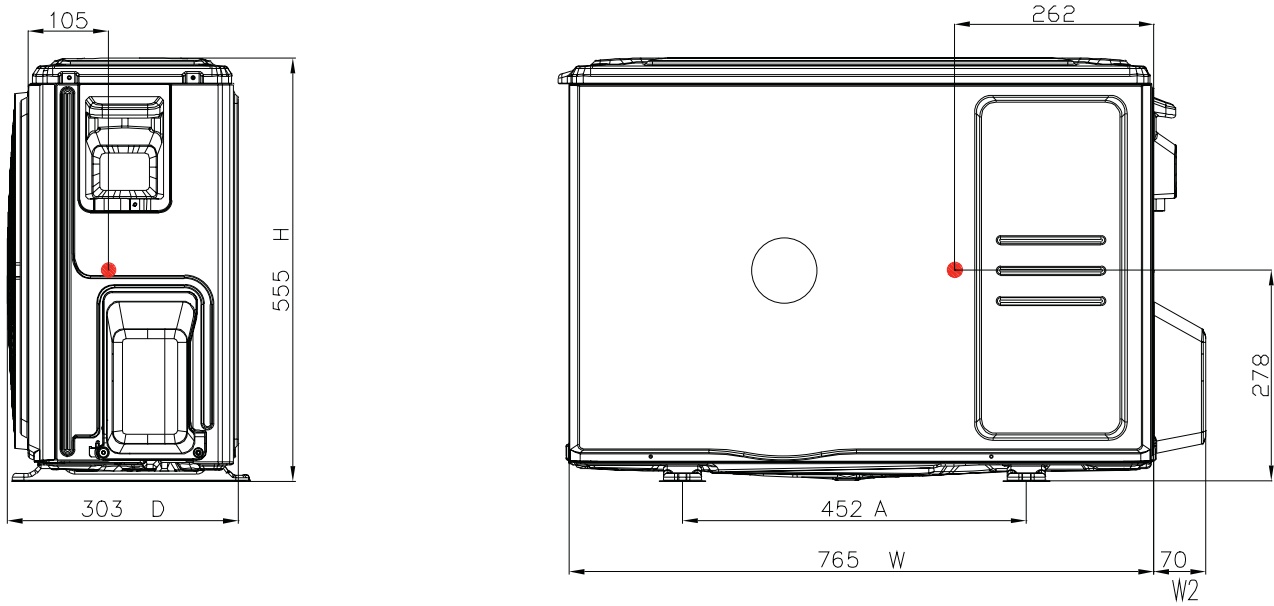

KSRA70HFRN1

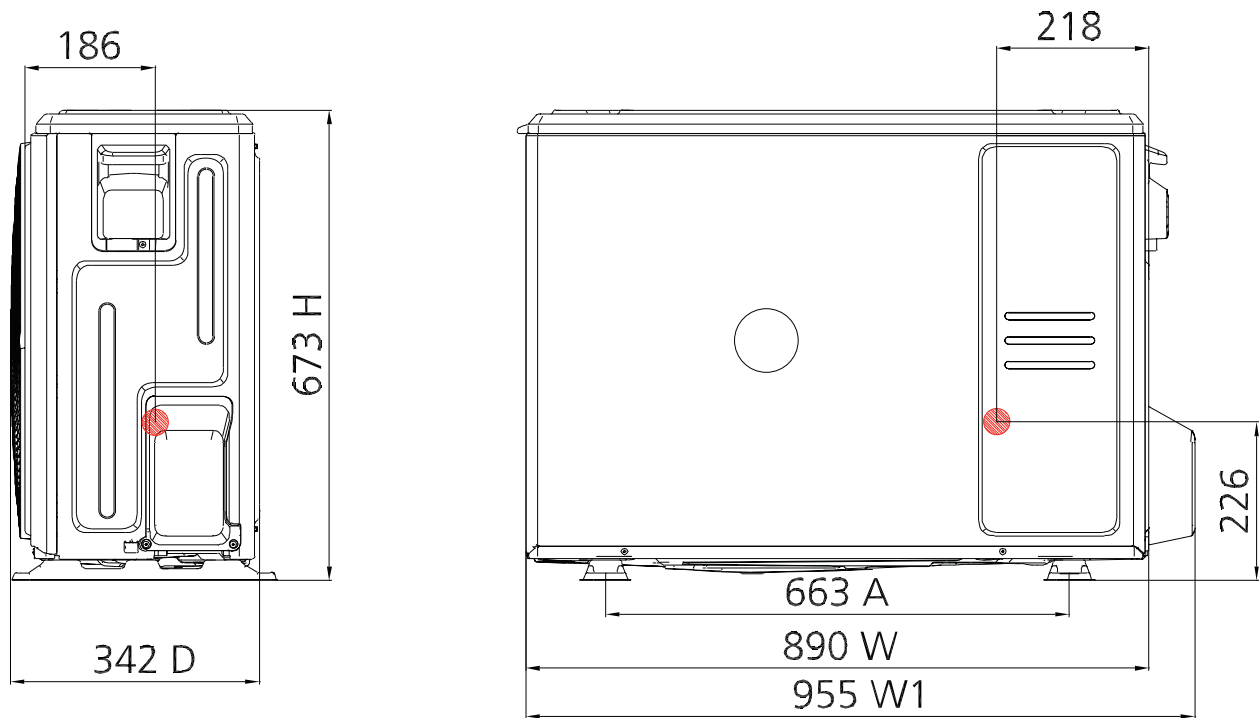

Units: mm

5. Air Velocity and Temperature Distributions

KSGA21HFRN1 - Cooling (ID: 27°C/80.6°F, OD: 35°C/95°F)

Discharge Angle 58°

Airflow velocity distributions

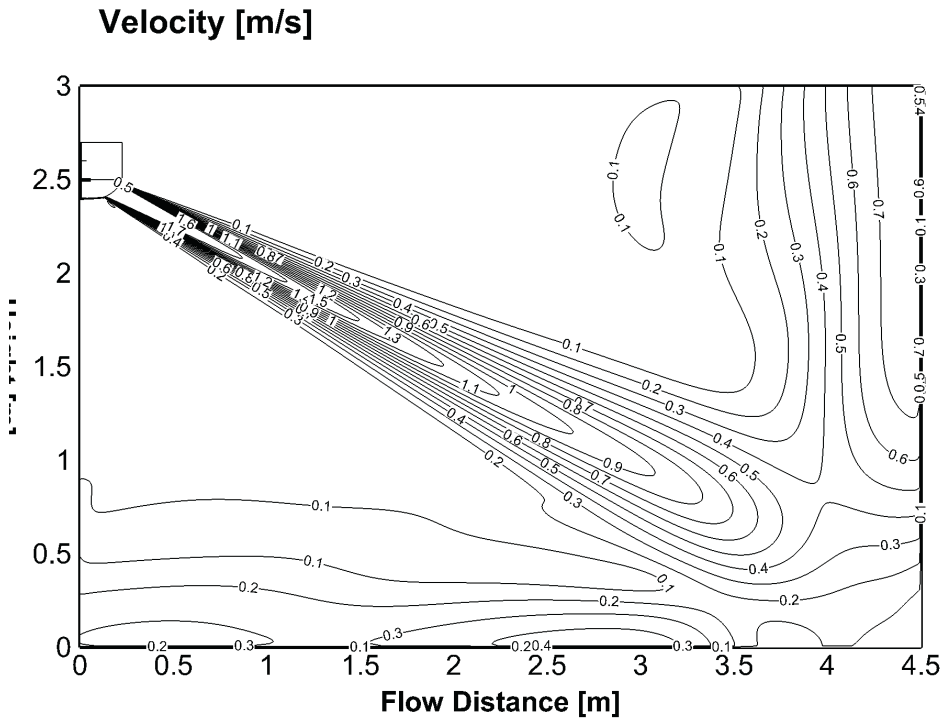

Temperature distributions

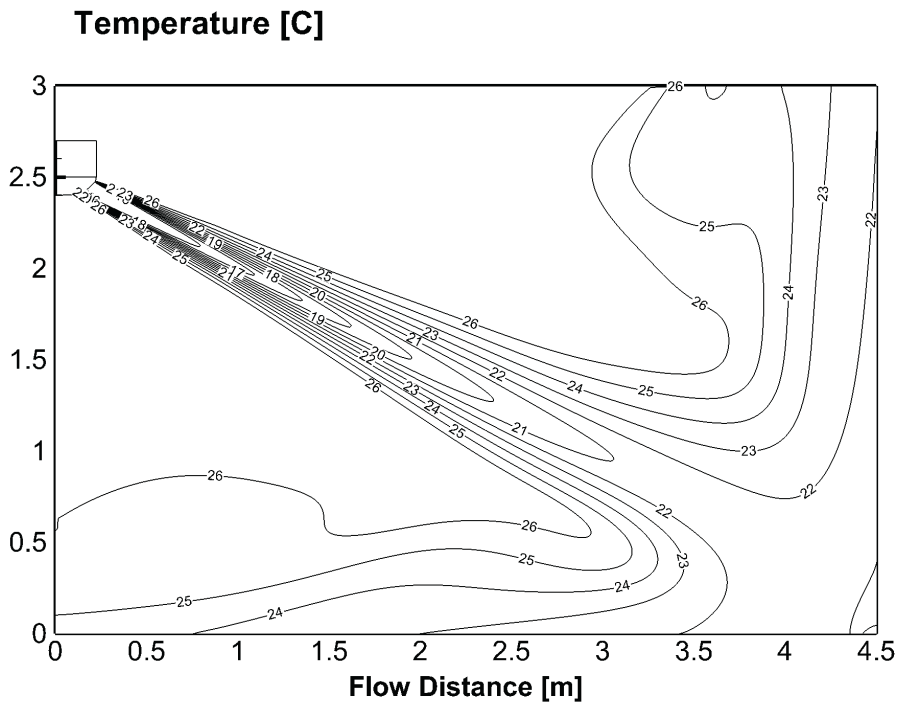

KSGA21HFRN1 - Heating (ID: 20°C/68°F, OD: 7°C/44.6°F)

Discharge Angle 90°

Airflow velocity distributions

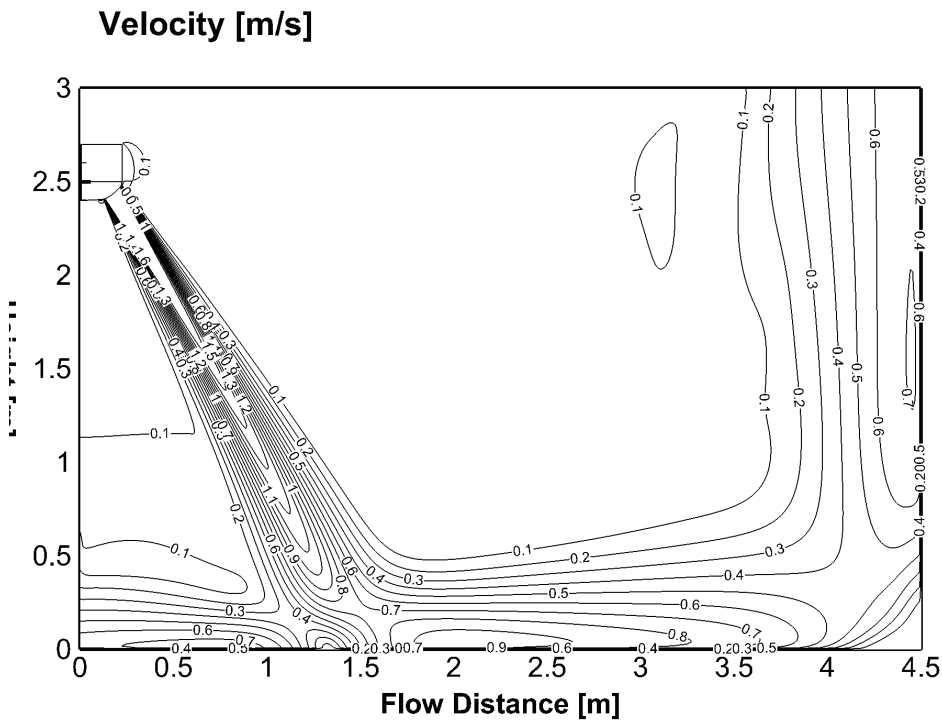

Temperature distributions

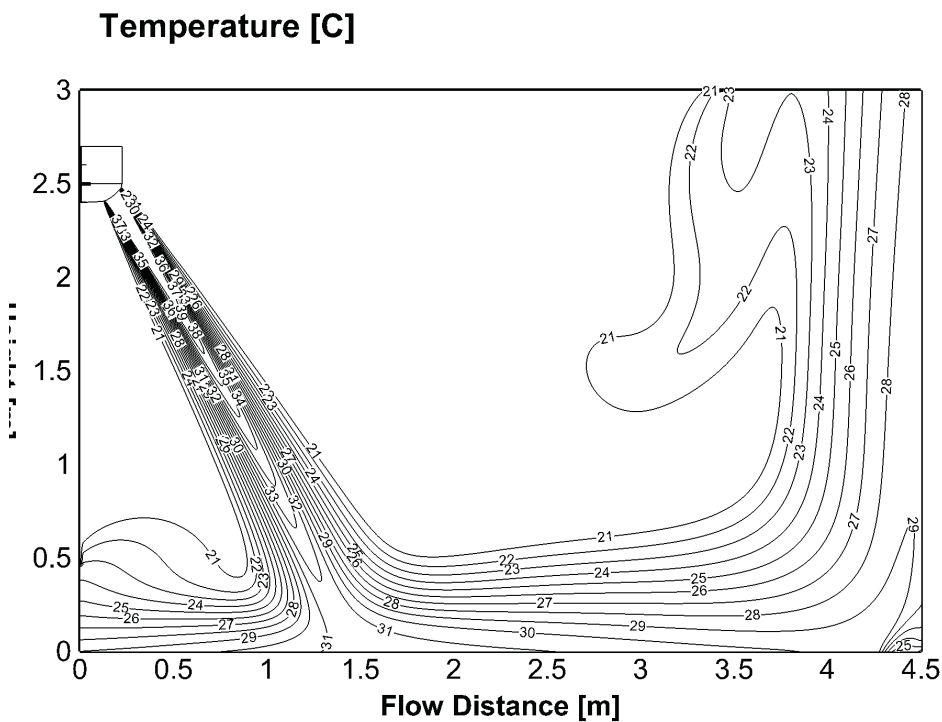

KSGA26HFRN1 - Cooling(ID: 27°C/80.6°F, OD: 35°C/95°F)

Discharge Angle 58°

Airflow velocity distributions

Velocity [m/s]

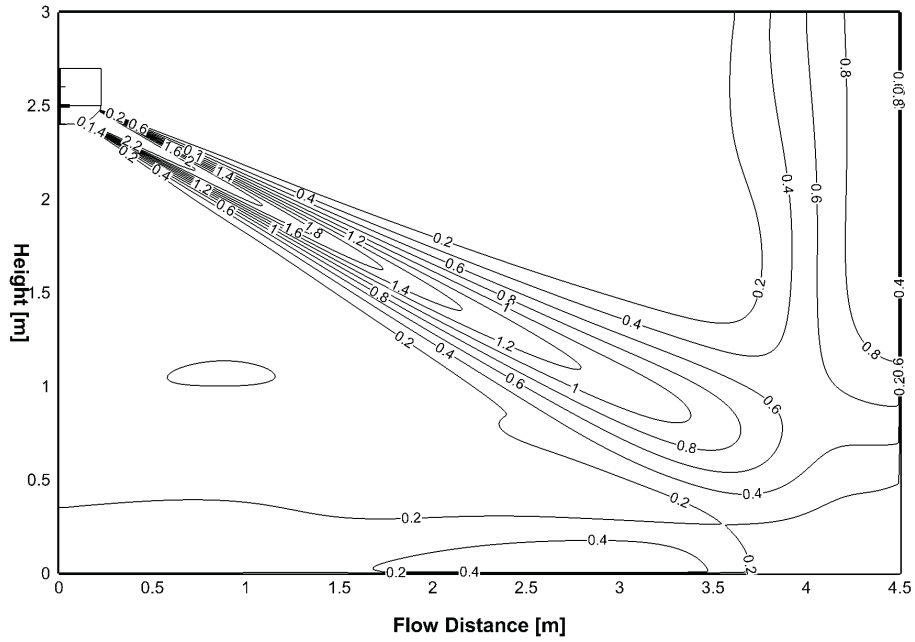

Temperature distributions

Temperature [C]

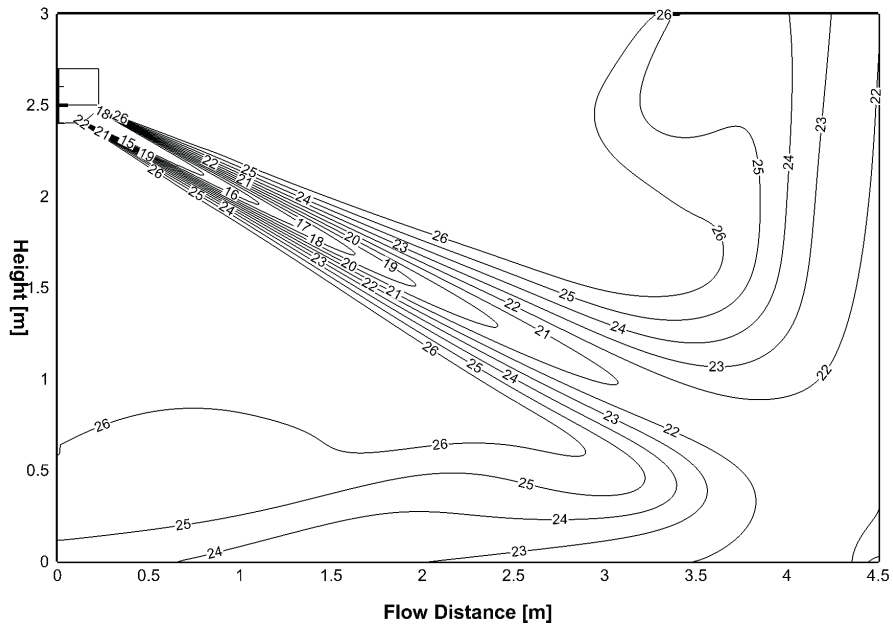

KSGA26HFRN1 - Heating (ID: 20°C/68°F, OD: 7°C/44.6°F)

Discharge Angle 90°

Airflow velocity distributions

Velocity [m/s]

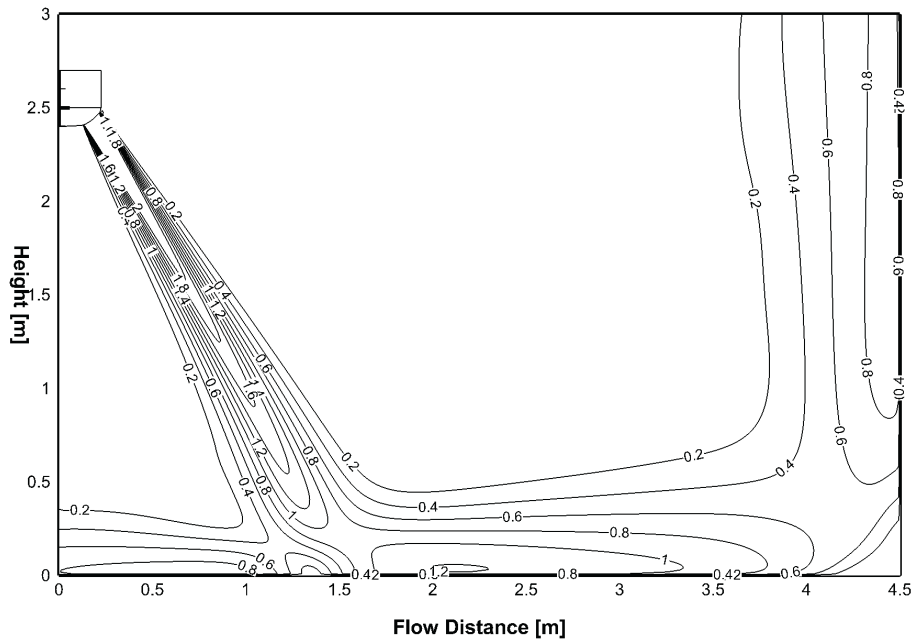

Temperature distributions

Temperature [C]

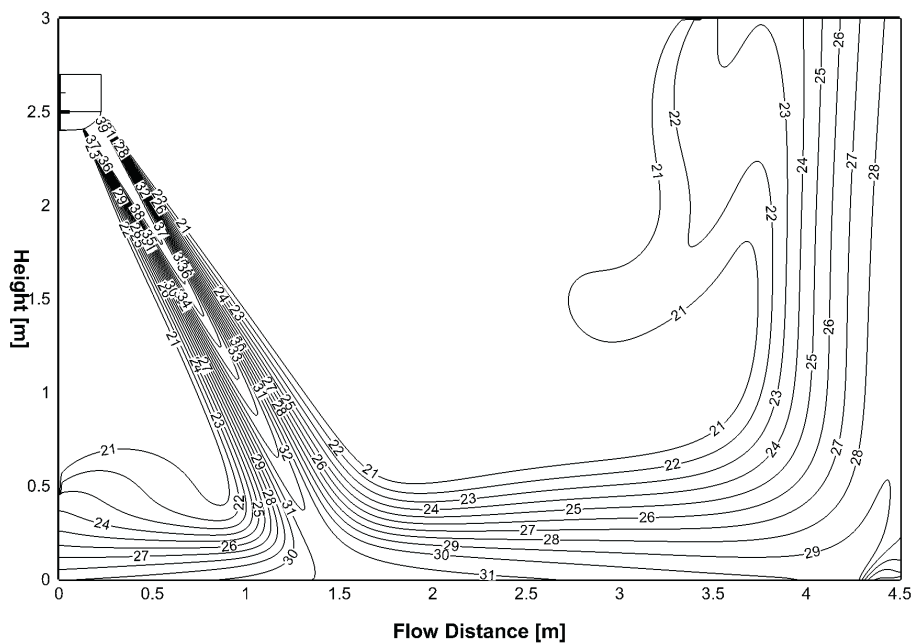

KSGA35HFRN1 - Cooling (ID: 27°C/80.6°F, OD: 35°C/95°F)

Discharge Angle 58°

Airflow velocity distributions

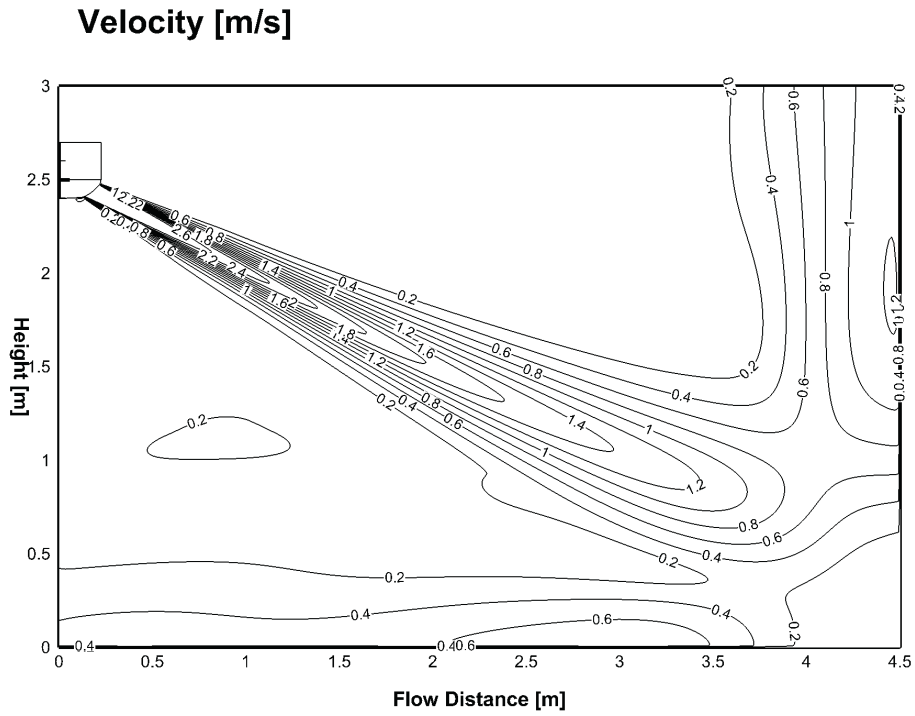

Temperature distributions

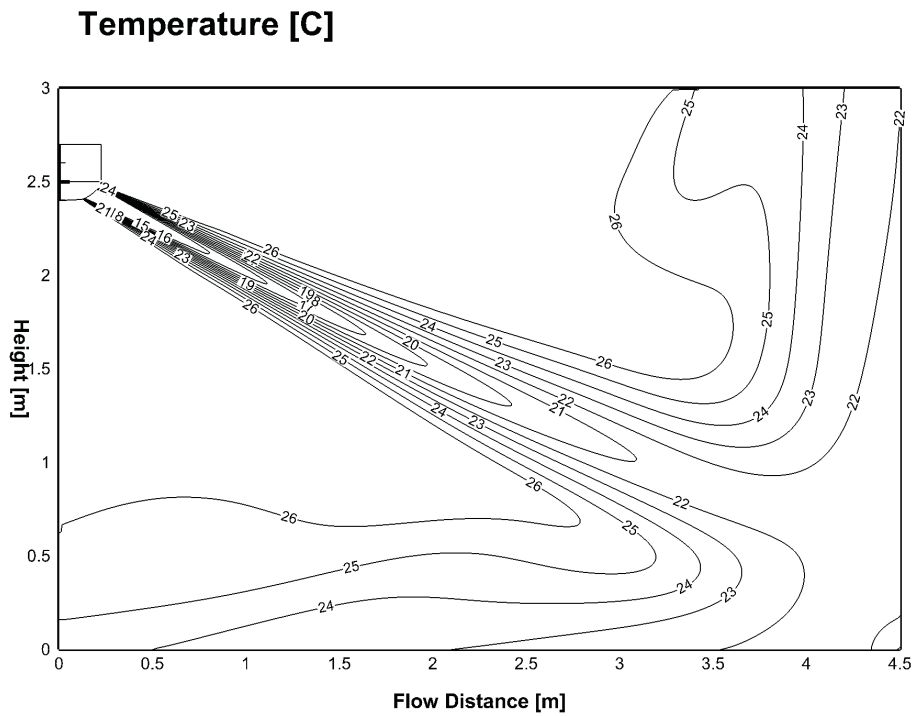

KSGA35HFRN1 - Heating (ID: 20°C/68°F, OD: 7°C/44.6°F)

Discharge Angle 90°

Airflow velocity distributions

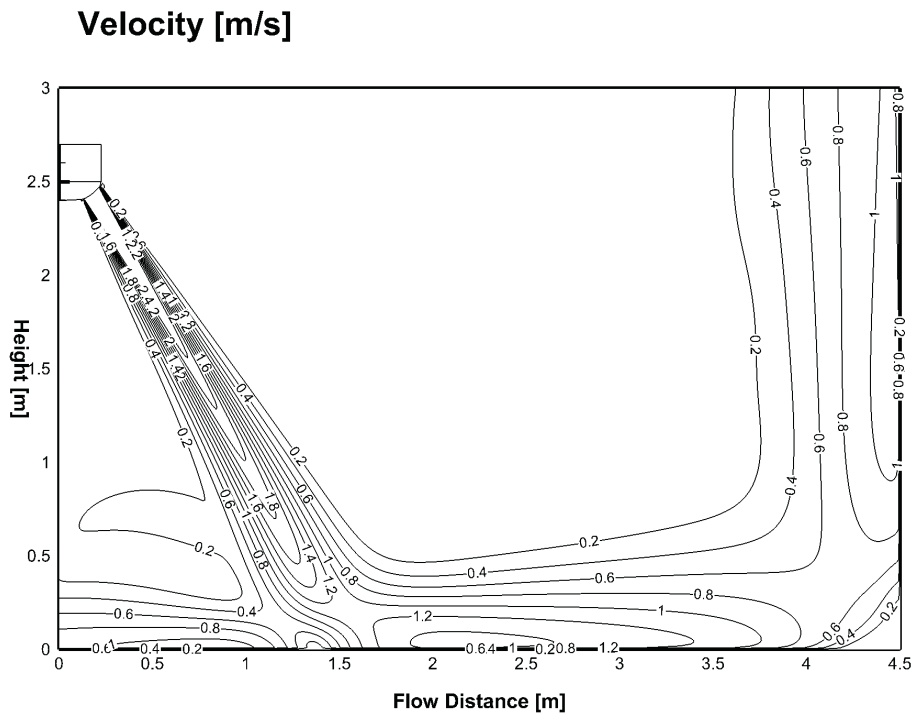

KSGA53HFRN1 - Cooling (ID: 27°C/80.6°F, OD: 35°C/95°F)

Discharge Angle 50°

Airflow velocity distributions

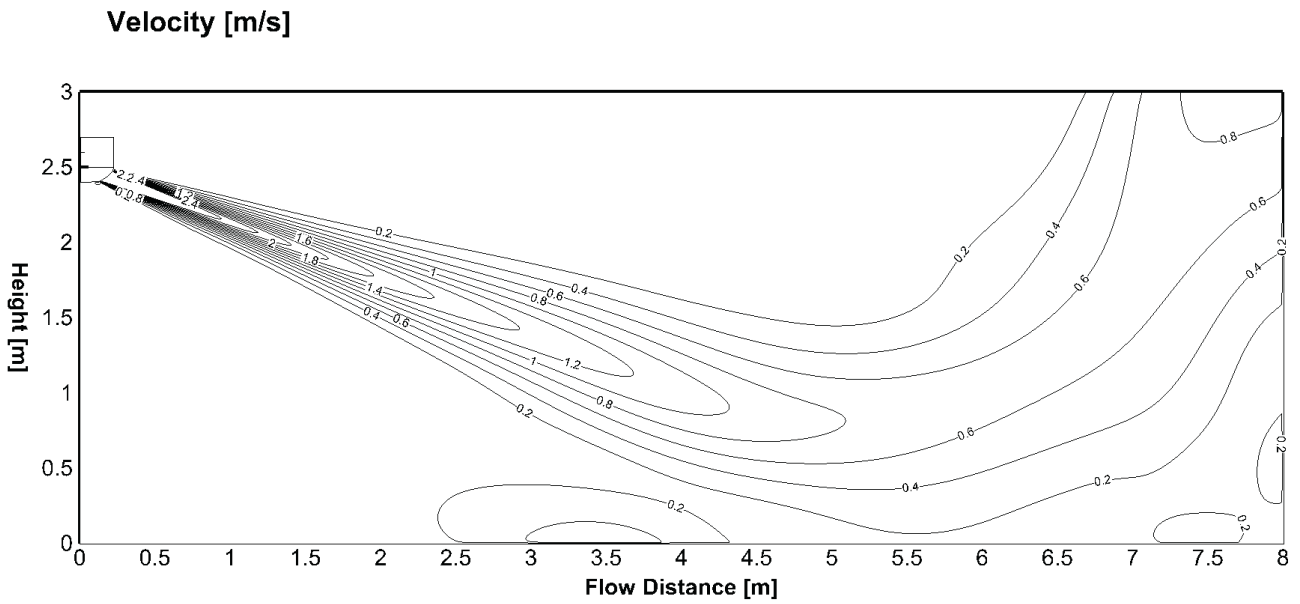

Temperature distributions

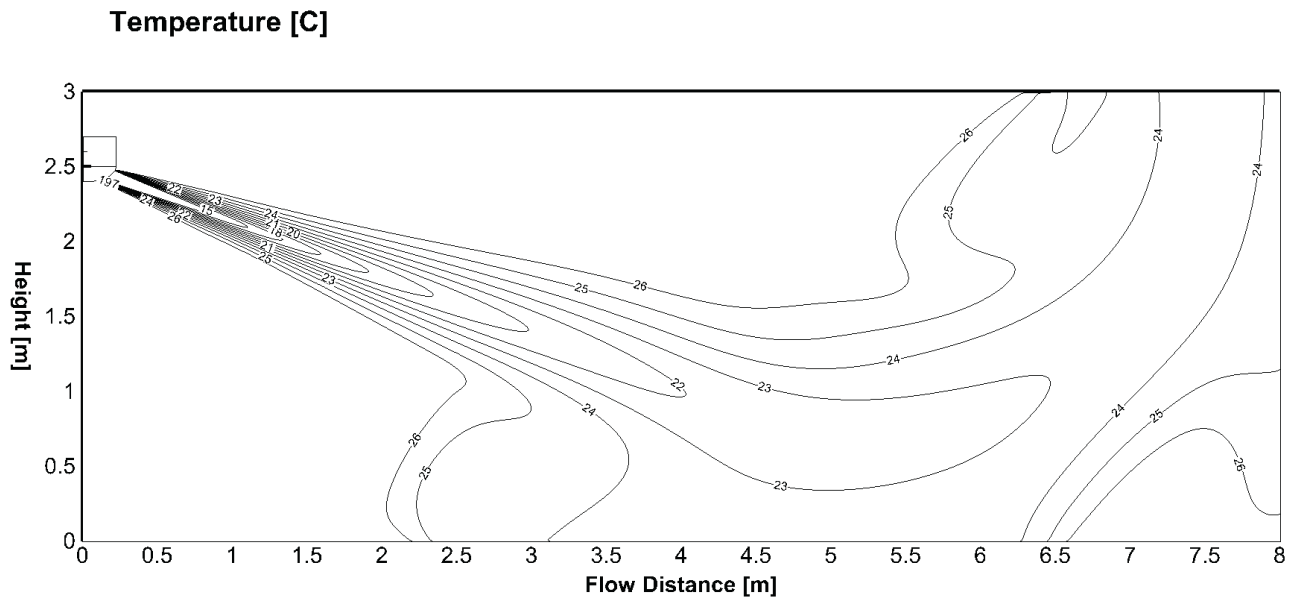

KSGA53HFRN1 - Heating (ID: 20°C/68°F, OD: 7°C/44.6°F)

Discharge Angle 84°

Airflow velocity distributions

Velocity [m/s]

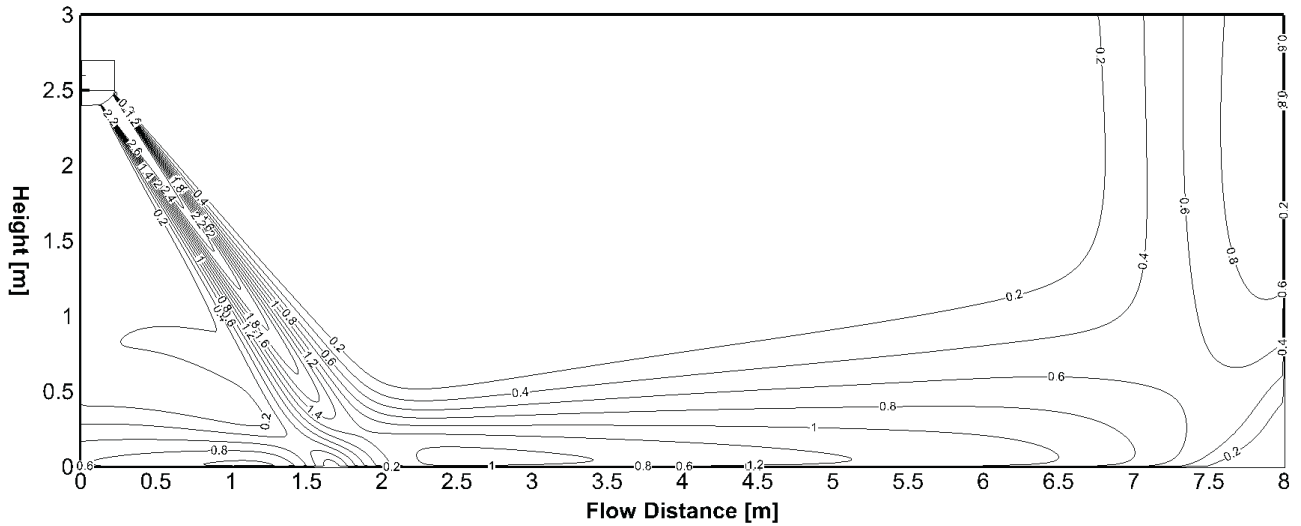

Temperature distributions

Temperature [C]

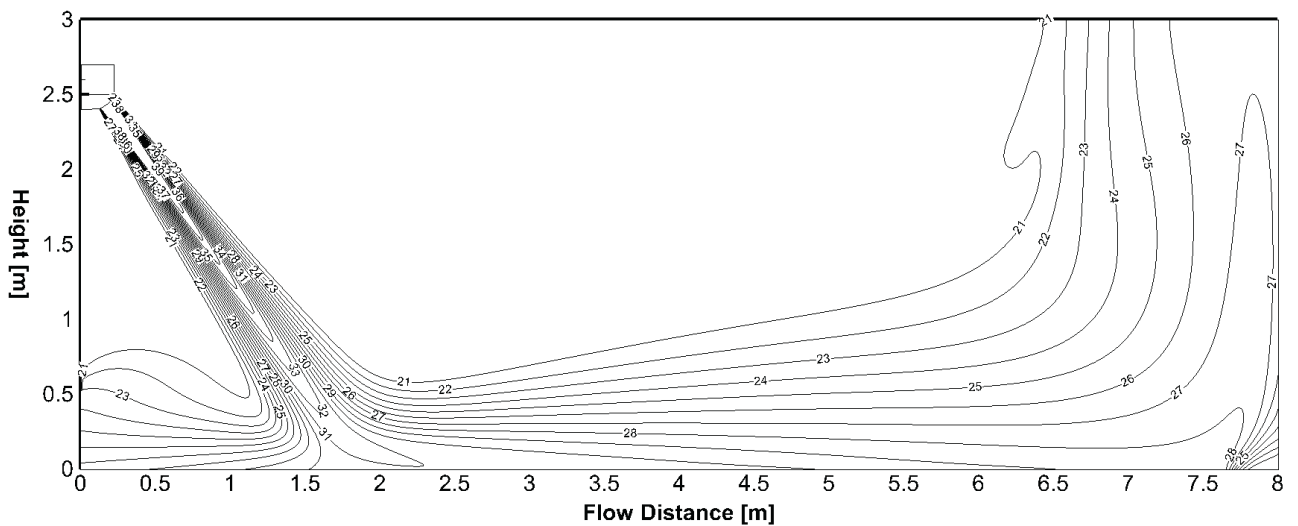

KSGA70HFRN1 - Cooling (ID: 27°C/80.6°F, OD: 35°C/95°F)

Discharge Angle 50°

Airflow velocity distributions

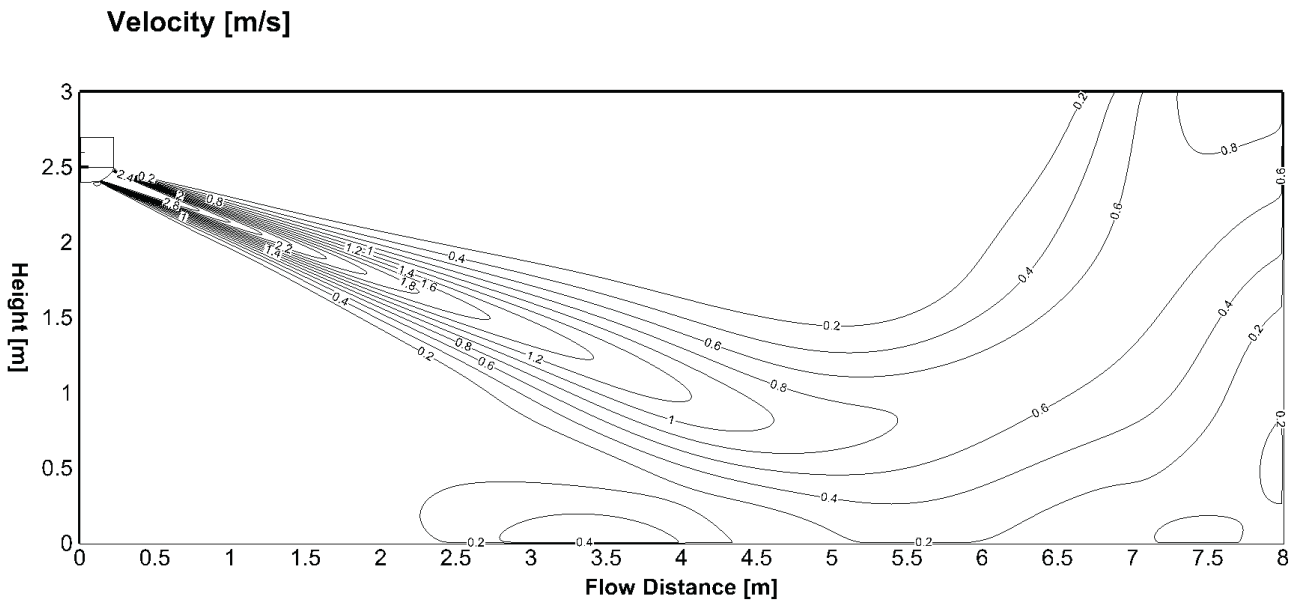

Temperature distributions

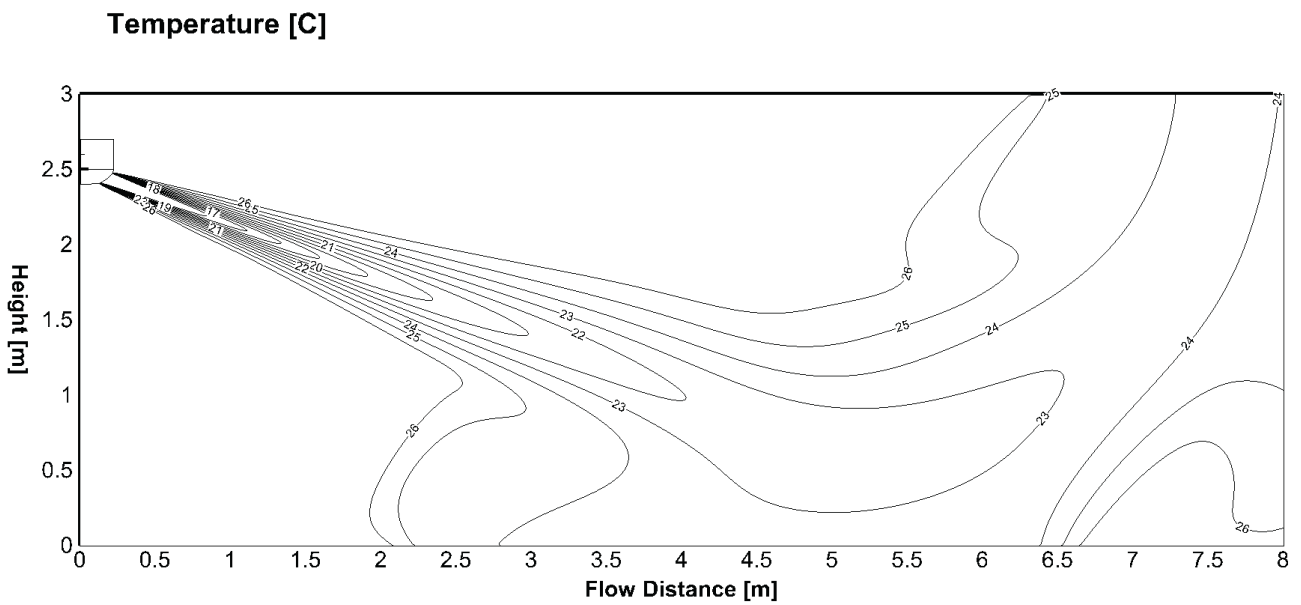

KSGA70HFRN1 - Heating (ID: 20°C/68°F, OD: 7°C/44.6°F)

Discharge Angle 77°

Airflow velocity distributions

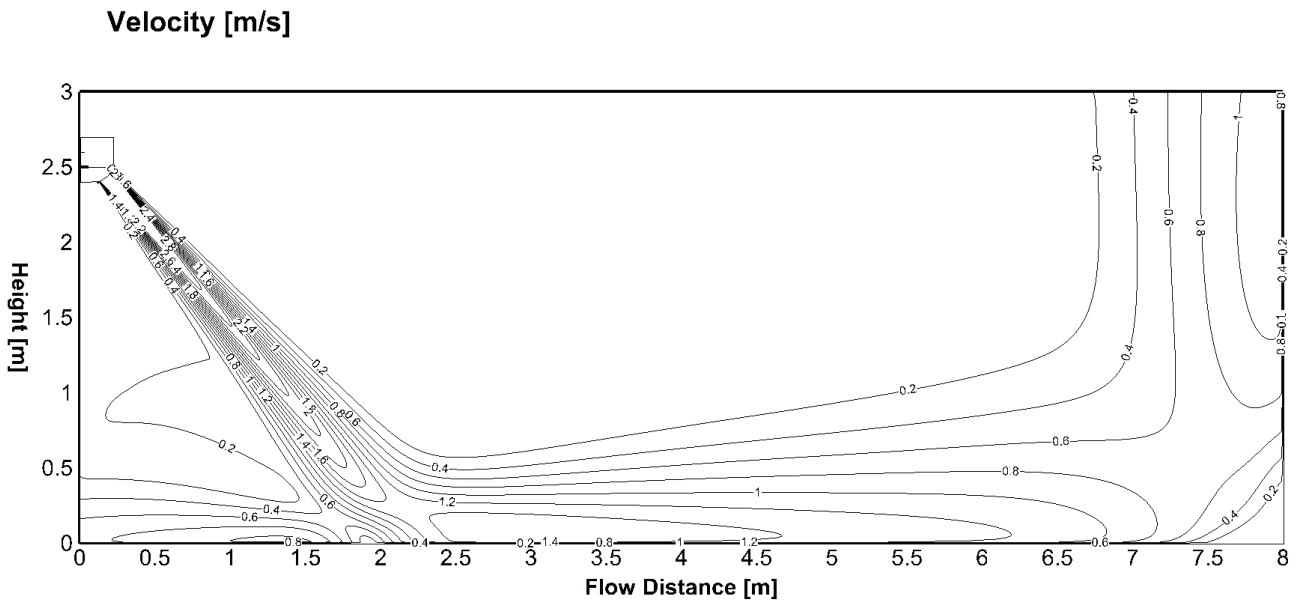

Temperature distributions

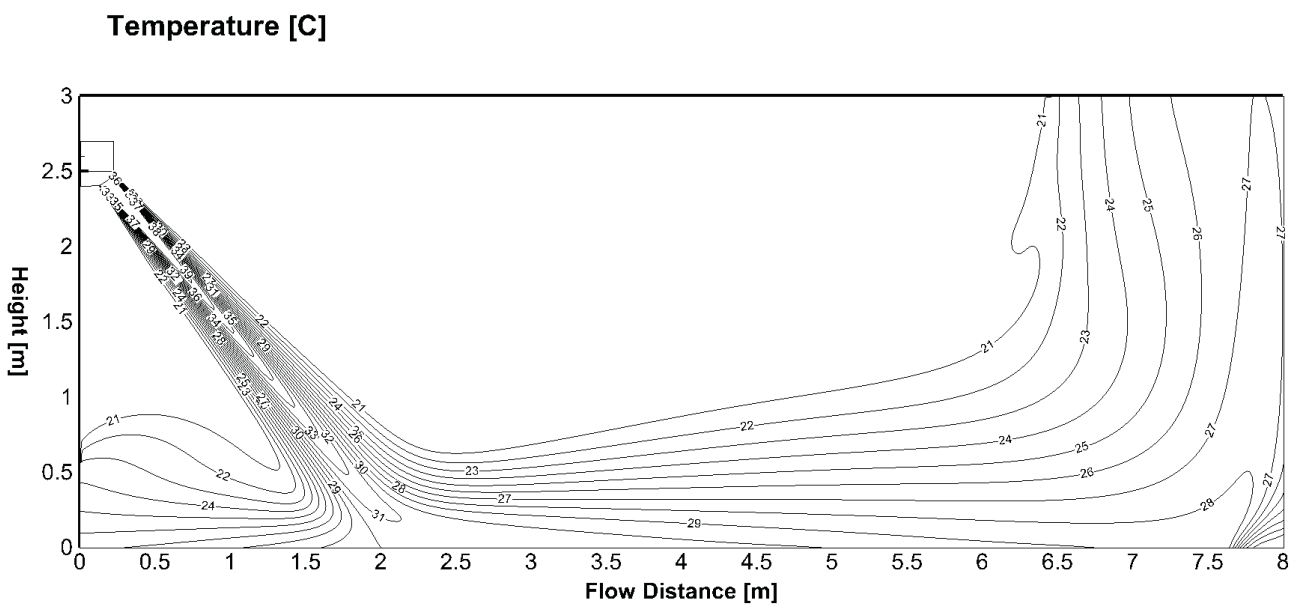

6. Electrical Wiring Diagrams

6.1 Indoor unit

| Abbreviation | Paraphrase |
|--------------|-------------------------------------|
| Y/G | Yellow-Green Conductor |
| ION | Positive and Negative Ion Generator |
| CAP | Capacitor |
| PLASMA | Electronic Dust Collector |
| L | LIVE |
| N | NEUTRAL |
| T1 | Indoor Room Temperature Sensor |
| T2 | Indoor Coil Temperature Sensor |

KSGA21HFRN1, KSGA26HFRN1, KSGA35HFRN1, KSGA53HFRN1

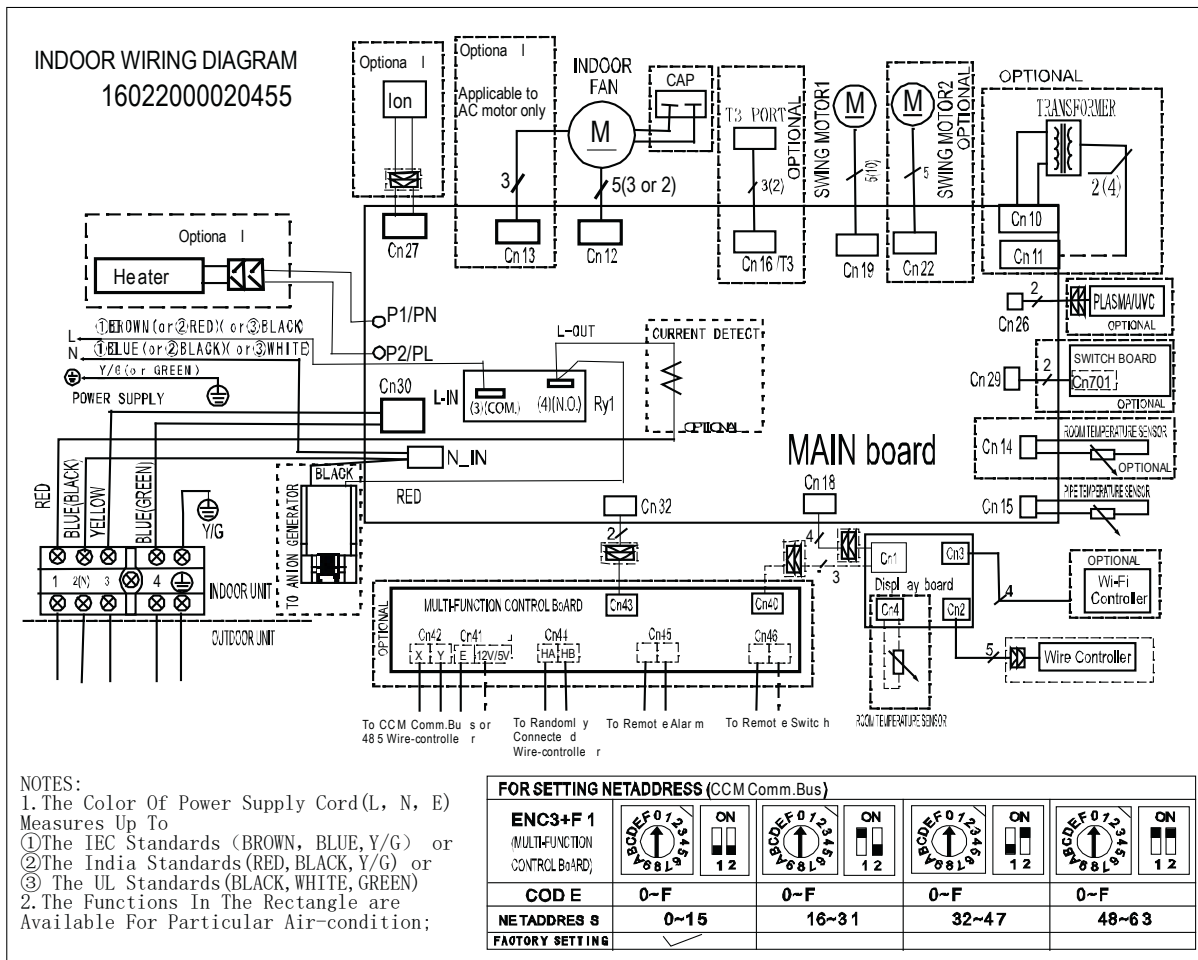

KSGA70HFRN1

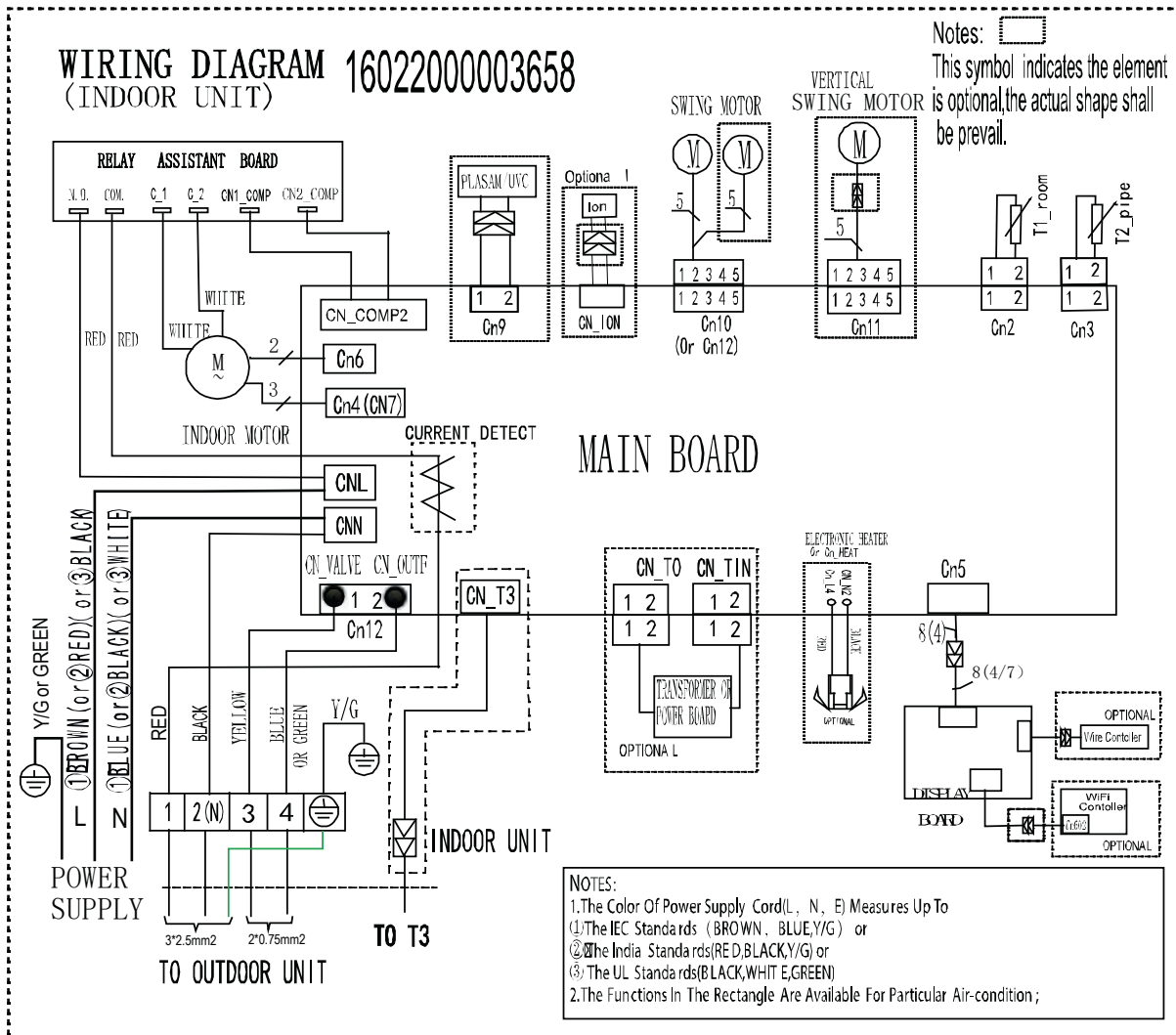

6.2 Outdoor Unit

| Abbreviation | Paraphrase |
|--------------|------------------------------------|
| 4-WAY | Gas Valve Assembly/4-WAY VALVE |
| COMP | Compressor |
| T3 | Outdoor Coil Temperature Sensor |
| T4 | Outdoor Ambient Temperature Sensor |

KSRA21HFRN1, KSRA26HFRN1, KSRA35HFRN1, KSRA53HFRN1, KSRA70HFRN1

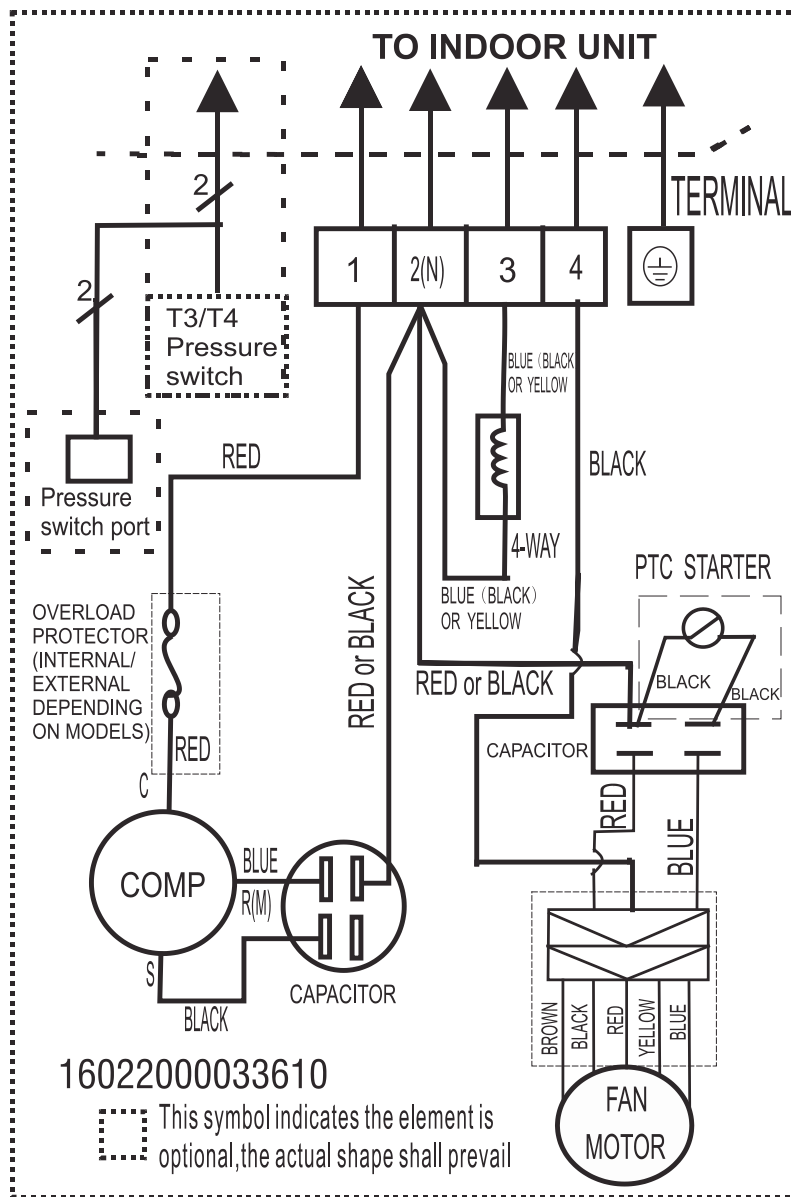

7. Refrigerant Cycle Diagrams

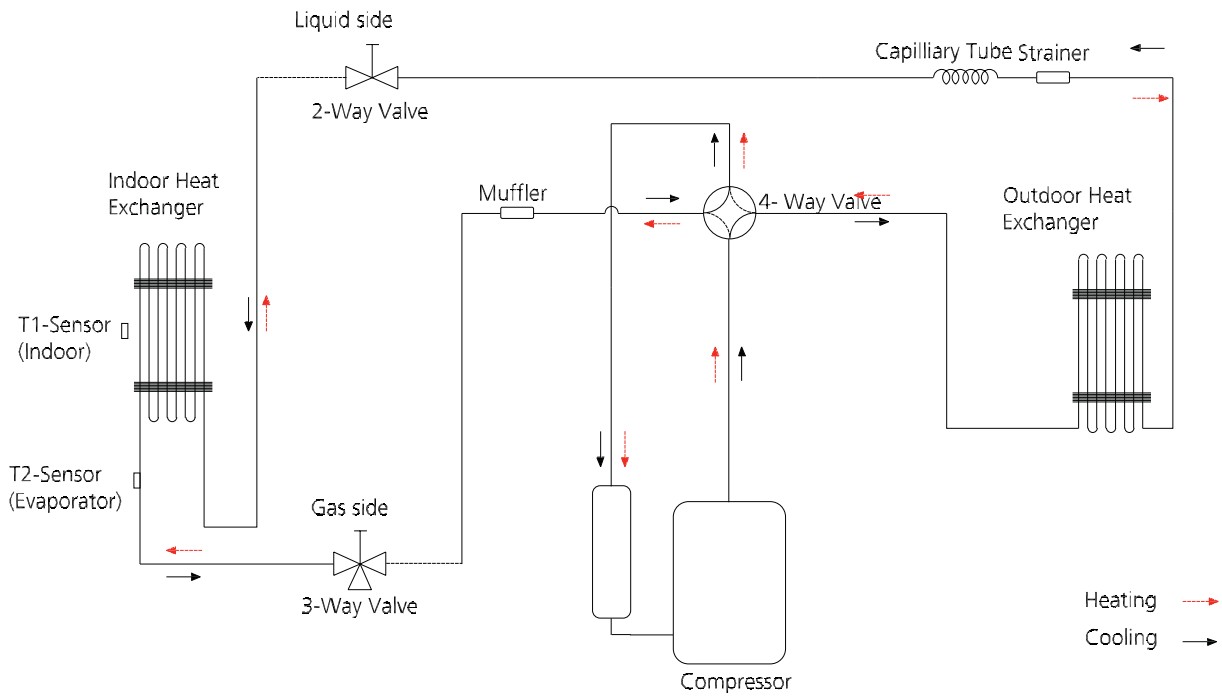

| Model | Pipe Size (Diameter:ø) (mm) | | Piping length (m/ft) | | Elevation (m/ft) | | Additional Refrigerant |
|------------------------------|--------------------------------|--------|----------------------|------|------------------|------|------------------------|
| | Gas | Liquid | Rated | Max. | Rated | Max. | |
| KSGA21HFRN1 / KSRA21HFRN1 | 9.52 | 6.35 | 5 | 20 | 0 | 8 | 12g/m |

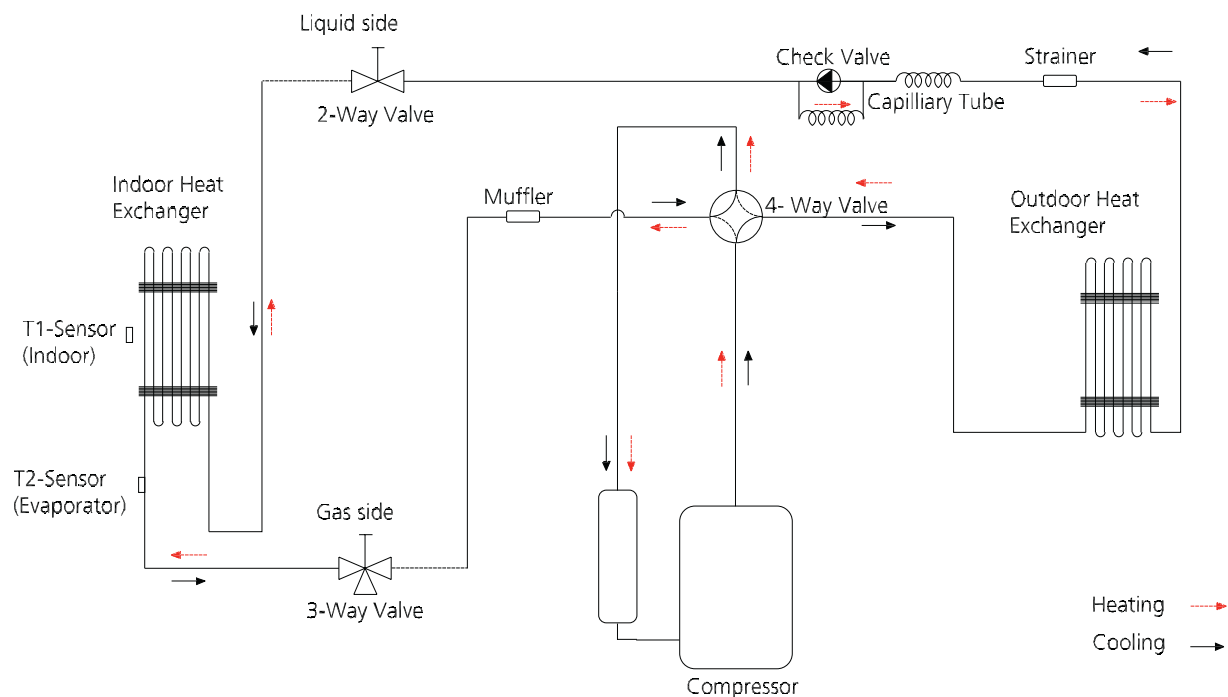

| Model | Pipe Size (Diameter:ø) (mm) | | Piping length (m) | | Elevation (m) | | Additional Refrigerant |
|---------------------------|-----------------------------|--------|-------------------|------|---------------|------|------------------------|
| | Gas | Liquid | Rated | Max. | Rated | Max. | |
| KSGA26HFRN1 / KSRA26HFRN1 | 9.52 | 6.35 | 5 | 20 | 0 | 8 | 12g/m |
| KSGA35HFRN1 / KSRA35HFRN1 | 12.7 | 6.35 | 5 | 20 | 0 | 8 | |
| KSGA53HFRN1 / KSRA53HFRN1 | 12.7 | 6.35 | | 25 | 0 | 10 | |

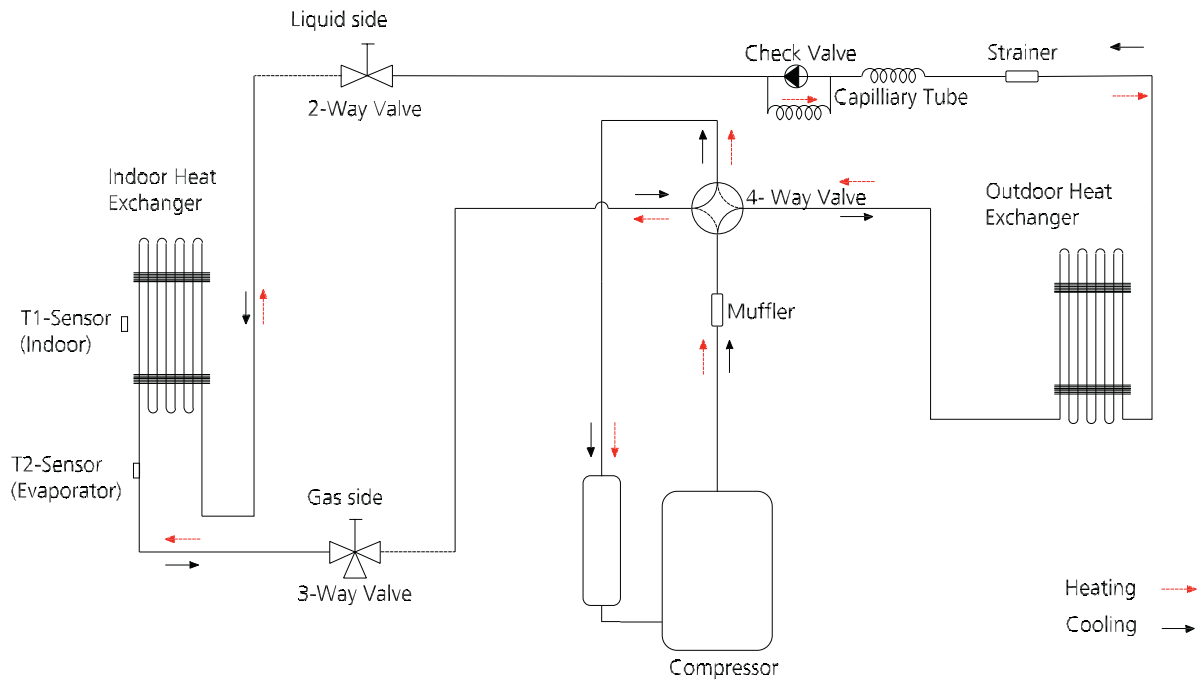

| Model | Pipe Size (Diameter:ø) (mm) | | Piping length (m/ft) | | Elevation (m/ft) | | Additional Refrigerant |
|------------------------------|--------------------------------|--------|----------------------|------|------------------|------|------------------------|
| | Gas | Liquid | Rated | Max. | Rated | Max. | |
| KSGA70HFRN1 / KSRA70HFRN1 | 15.9 | 9.52 | 5 | 25 | 0 | 10 | 24g/m |

8. Capacity Tables

8.1 Cooling

| | | KSGA21HFRN1 / KSRA21HFRN1 | | | | | | | | | | | | | | | | |
|------------------------|-----------------|---------------------------|------------|------|------|------|------|------|------|------|------|------|------|------|------|------|------|------|
| IN-DOOR AIR-FLOW (CMH) | OUT-DOOR DB(°C) | ID WB (°C) | 16.0 | | | | 18.0 | | | | 19.0 | | | | 22.0 | | | |
| | | | ID DB (°C) | 23.0 | 25.0 | 27.0 | 29.0 | 23.0 | 25.0 | 27.0 | 29.0 | 23.0 | 25.0 | 27.0 | 29.0 | 23.0 | 25.0 | 27.0 |
| 320 | 18 | TC | 2.36 | 2.37 | 2.40 | 2.43 | 2.50 | 2.51 | 2.51 | 2.51 | 2.57 | 2.57 | 2.57 | 2.57 | 2.77 | 2.77 | 2.77 | 2.77 |
| | | S/T | 0.73 | 0.82 | 0.90 | 0.99 | 0.58 | 0.67 | 0.75 | 0.84 | 0.52 | 0.60 | 0.68 | 0.76 | 0.36 | 0.44 | 0.51 | 0.59 |
| | | PI | 0.51 | 0.51 | 0.51 | 0.51 | 0.51 | 0.51 | 0.51 | 0.51 | 0.51 | 0.51 | 0.51 | 0.51 | 0.50 | 0.50 | 0.50 | 0.50 |
| | 25 | TC | 2.20 | 2.20 | 2.23 | 2.26 | 2.34 | 2.34 | 2.34 | 2.34 | 2.43 | 2.43 | 2.43 | 2.43 | 2.60 | 2.60 | 2.60 | 2.60 |
| | | S/T | 0.74 | 0.84 | 0.93 | 1.00 | 0.59 | 0.68 | 0.77 | 0.86 | 0.52 | 0.61 | 0.69 | 0.78 | 0.35 | 0.44 | 0.52 | 0.60 |
| | | PI | 0.59 | 0.59 | 0.59 | 0.59 | 0.59 | 0.59 | 0.59 | 0.59 | 0.59 | 0.59 | 0.59 | 0.59 | 0.59 | 0.59 | 0.59 | 0.59 |
| | 30 | TC | 2.11 | 2.11 | 2.14 | 2.17 | 2.23 | 2.23 | 2.23 | 2.23 | 2.31 | 2.31 | 2.31 | 2.31 | 2.49 | 2.49 | 2.49 | 2.49 |
| | | S/T | 0.75 | 0.85 | 0.95 | 1.00 | 0.60 | 0.69 | 0.79 | 0.88 | 0.52 | 0.61 | 0.71 | 0.80 | 0.35 | 0.44 | 0.52 | 0.61 |
| | | PI | 0.64 | 0.64 | 0.64 | 0.64 | 0.65 | 0.65 | 0.65 | 0.65 | 0.65 | 0.65 | 0.65 | 0.65 | 0.65 | 0.65 | 0.65 | 0.65 |
| | 35 | TC | 2.00 | 2.00 | 2.03 | 2.06 | 2.11 | 2.11 | 2.11 | 2.14 | 2.20 | 2.20 | 2.23 | 2.20 | 2.37 | 2.37 | 2.37 | 2.37 |
| | | S/T | 0.77 | 0.87 | 0.97 | 1.00 | 0.60 | 0.70 | 0.80 | 0.90 | 0.52 | 0.62 | 0.71 | 0.82 | 0.35 | 0.44 | 0.53 | 0.62 |
| | | PI | 0.70 | 0.70 | 0.70 | 0.70 | 0.71 | 0.71 | 0.71 | 0.71 | 0.71 | 0.71 | 0.71 | 0.71 | 0.71 | 0.71 | 0.71 | 0.71 |
| 40 | TC | 1.81 | 1.82 | 1.85 | 1.88 | 1.92 | 1.92 | 1.92 | 1.95 | 1.98 | 1.98 | 2.00 | 1.98 | 2.15 | 2.15 | 2.15 | 2.15 | |
| | S/T | 0.79 | 0.90 | 1.00 | 1.00 | 0.61 | 0.72 | 0.83 | 0.94 | 0.53 | 0.64 | 0.74 | 0.85 | 0.34 | 0.44 | 0.54 | 0.64 | |
| | PI | 0.80 | 0.80 | 0.80 | 0.80 | 0.80 | 0.80 | 0.80 | 0.80 | 0.80 | 0.80 | 0.80 | 0.80 | 0.81 | 0.81 | 0.81 | 0.81 | |
| 43 | TC | 1.71 | 1.74 | 1.77 | 1.80 | 1.82 | 1.82 | 1.82 | 1.85 | 1.88 | 1.88 | 1.88 | 1.88 | 2.05 | 2.05 | 2.05 | 2.05 | |
| | S/T | 0.81 | 0.92 | 1.00 | 1.00 | 0.62 | 0.74 | 0.85 | 0.96 | 0.53 | 0.65 | 0.76 | 0.87 | 0.34 | 0.44 | 0.54 | 0.65 | |
| | PI | 0.86 | 0.86 | 0.86 | 0.86 | 0.86 | 0.86 | 0.86 | 0.86 | 0.86 | 0.86 | 0.86 | 0.86 | 0.87 | 0.87 | 0.87 | 0.87 | |
| 390 | 18 | TC | 2.43 | 2.43 | 2.46 | 2.49 | 2.57 | 2.57 | 2.57 | 2.60 | 2.63 | 2.63 | 2.63 | 2.63 | 2.83 | 2.83 | 2.83 | 2.83 |
| | | S/T | 0.77 | 0.87 | 0.98 | 1.00 | 0.60 | 0.70 | 0.80 | 0.90 | 0.53 | 0.62 | 0.72 | 0.82 | 0.35 | 0.44 | 0.53 | 0.62 |
| | | PI | 0.52 | 0.52 | 0.52 | 0.52 | 0.51 | 0.51 | 0.51 | 0.51 | 0.51 | 0.51 | 0.51 | 0.51 | 0.51 | 0.51 | 0.51 | 0.51 |
| | 25 | TC | 2.26 | 2.29 | 2.32 | 2.34 | 2.40 | 2.40 | 2.40 | 2.43 | 2.49 | 2.49 | 2.49 | 2.49 | 2.66 | 2.66 | 2.66 | 2.66 |
| | | S/T | 0.79 | 0.90 | 1.00 | 1.00 | 0.61 | 0.72 | 0.83 | 0.93 | 0.53 | 0.63 | 0.74 | 0.84 | 0.34 | 0.44 | 0.54 | 0.64 |
| | | PI | 0.60 | 0.60 | 0.60 | 0.60 | 0.59 | 0.59 | 0.59 | 0.59 | 0.59 | 0.59 | 0.59 | 0.59 | 0.60 | 0.60 | 0.60 | 0.60 |
| | 30 | TC | 2.17 | 2.20 | 2.23 | 2.26 | 2.29 | 2.29 | 2.29 | 2.32 | 2.37 | 2.37 | 2.37 | 2.37 | 2.54 | 2.54 | 2.54 | 2.54 |
| | | S/T | 0.80 | 0.91 | 1.00 | 1.00 | 0.62 | 0.73 | 0.85 | 0.95 | 0.53 | 0.64 | 0.75 | 0.86 | 0.34 | 0.44 | 0.54 | 0.65 |
| | | PI | 0.65 | 0.65 | 0.65 | 0.65 | 0.65 | 0.65 | 0.65 | 0.65 | 0.66 | 0.66 | 0.66 | 0.66 | 0.66 | 0.66 | 0.66 | 0.66 |
| | 35 | TC | 2.06 | 2.09 | 2.12 | 2.14 | 2.17 | 2.17 | 2.17 | 2.20 | 2.26 | 2.26 | 2.29 | 2.26 | 2.43 | 2.43 | 2.43 | 2.43 |
| | | S/T | 0.82 | 0.94 | 1.00 | 1.00 | 0.63 | 0.75 | 0.87 | 0.98 | 0.54 | 0.65 | 0.76 | 0.88 | 0.34 | 0.44 | 0.55 | 0.66 |
| | | PI | 0.71 | 0.71 | 0.71 | 0.71 | 0.72 | 0.72 | 0.72 | 0.72 | 0.72 | 0.72 | 0.72 | 0.72 | 0.72 | 0.72 | 0.72 | 0.72 |
| 40 | TC | 1.87 | 1.89 | 1.92 | 1.95 | 1.98 | 1.98 | 2.00 | 2.02 | 2.04 | 2.04 | 2.06 | 2.06 | 2.21 | 2.21 | 2.21 | 2.21 | |
| | S/T | 0.85 | 0.98 | 1.00 | 1.00 | 0.64 | 0.77 | 0.90 | 1.00 | 0.55 | 0.67 | 0.80 | 0.92 | 0.33 | 0.45 | 0.57 | 0.68 | |
| | PI | 0.82 | 0.82 | 0.82 | 0.82 | 0.82 | 0.82 | 0.82 | 0.82 | 0.83 | 0.83 | 0.83 | 0.83 | 0.83 | 0.83 | 0.83 | 0.83 | |
| 43 | TC | 1.77 | 1.80 | 1.83 | 1.85 | 1.88 | 1.88 | 1.91 | 1.94 | 1.94 | 1.94 | 1.94 | 1.97 | 2.11 | 2.11 | 2.11 | 2.11 | |
| | S/T | 0.86 | 1.00 | 1.00 | 1.00 | 0.65 | 0.79 | 0.92 | 1.00 | 0.55 | 0.69 | 0.82 | 0.94 | 0.33 | 0.45 | 0.57 | 0.69 | |
| | PI | 0.88 | 0.88 | 0.88 | 0.88 | 0.88 | 0.88 | 0.88 | 0.88 | 0.89 | 0.89 | 0.89 | 0.89 | 0.89 | 0.89 | 0.89 | 0.89 | |
| 470 | 18 | TC | 2.49 | 2.52 | 2.54 | 2.57 | 2.63 | 2.63 | 2.63 | 2.66 | 2.72 | 2.72 | 2.72 | 2.74 | 2.92 | 2.92 | 2.92 | 2.92 |
| | | S/T | 0.82 | 0.94 | 1.00 | 1.00 | 0.63 | 0.75 | 0.87 | 0.98 | 0.54 | 0.65 | 0.77 | 0.88 | 0.34 | 0.44 | 0.55 | 0.66 |
| | | PI | 0.52 | 0.52 | 0.52 | 0.52 | 0.52 | 0.52 | 0.52 | 0.52 | 0.52 | 0.52 | 0.52 | 0.52 | 0.52 | 0.52 | 0.52 | 0.52 |
| | 25 | TC | 2.32 | 2.34 | 2.37 | 2.40 | 2.46 | 2.46 | 2.49 | 2.52 | 2.54 | 2.54 | 2.54 | 2.57 | 2.74 | 2.74 | 2.74 | 2.74 |
| | | S/T | 0.84 | 0.97 | 1.00 | 1.00 | 0.64 | 0.77 | 0.89 | 1.00 | 0.55 | 0.67 | 0.79 | 0.91 | 0.33 | 0.45 | 0.56 | 0.68 |
| | | PI | 0.60 | 0.60 | 0.60 | 0.60 | 0.60 | 0.60 | 0.60 | 0.60 | 0.60 | 0.60 | 0.60 | 0.60 | 0.60 | 0.60 | 0.60 | 0.60 |
| | 30 | TC | 2.20 | 2.23 | 2.26 | 2.29 | 2.34 | 2.34 | 2.37 | 2.40 | 2.43 | 2.43 | 2.43 | 2.46 | 2.60 | 2.60 | 2.60 | 2.60 |
| | | S/T | 0.86 | 0.99 | 1.00 | 1.00 | 0.65 | 0.78 | 0.91 | 1.00 | 0.55 | 0.68 | 0.81 | 0.93 | 0.33 | 0.45 | 0.57 | 0.69 |
| | | PI | 0.66 | 0.66 | 0.66 | 0.66 | 0.66 | 0.66 | 0.66 | 0.66 | 0.66 | 0.66 | 0.66 | 0.66 | 0.67 | 0.67 | 0.67 | 0.67 |
| | 35 | TC | 2.12 | 2.14 | 2.17 | 2.20 | 2.23 | 2.23 | 2.26 | 2.29 | 2.32 | 2.32 | 2.34 | 2.37 | 2.49 | 2.49 | 2.49 | 2.49 |
| | | S/T | 0.87 | 1.00 | 1.00 | 1.00 | 0.66 | 0.80 | 0.93 | 1.00 | 0.56 | 0.69 | 0.82 | 0.95 | 0.33 | 0.45 | 0.58 | 0.71 |
| | | PI | 0.72 | 0.72 | 0.72 | 0.72 | 0.73 | 0.73 | 0.73 | 0.73 | 0.73 | 0.73 | 0.73 | 0.73 | 0.73 | 0.73 | 0.73 | 0.73 |
| 40 | TC | 1.90 | 1.93 | 1.96 | 1.99 | 2.02 | 2.02 | 2.04 | 2.07 | 2.10 | 2.10 | 2.13 | 2.16 | 2.27 | 2.27 | 2.27 | 2.27 | |
| | S/T | 0.92 | 1.00 | 1.00 | 1.00 | 0.68 | 0.84 | 0.98 | 1.00 | 0.57 | 0.72 | 0.87 | 1.00 | 0.32 | 0.46 | 0.60 | 0.90 | |
| | PI | 0.83 | 0.83 | 0.83 | 0.83 | 0.84 | 0.84 | 0.84 | 0.84 | 0.84 | 0.84 | 0.84 | 0.84 | 0.84 | 0.84 | 0.84 | 0.84 | |
| 43 | TC | 1.80 | 1.83 | 1.85 | 1.88 | 1.91 | 1.91 | 1.94 | 1.97 | 2.00 | 2.00 | 2.02 | 2.05 | 2.16 | 2.16 | 2.16 | 2.16 | |
| | S/T | 0.94 | 1.00 | 1.00 | 1.00 | 0.69 | 0.85 | 1.00 | 1.00 | 0.58 | 0.73 | 0.88 | 1.00 | 0.32 | 0.46 | 0.61 | 0.92 | |
| | PI | 0.89 | 0.89 | 0.89 | 0.89 | 0.90 | 0.90 | 0.90 | 0.90 | 0.90 | 0.90 | 0.90 | 0.90 | 0.91 | 0.91 | 0.91 | 0.91 | |

TC:Total Cooling Capacity (kW)

S/T:Sensible Cooling Capacity Ratio

PI:Power Input(kW)

| KSGA26HFRN1 / KSRA26HFRN1 | | | | | | | | | | | | | | | | | | | | |
|---------------------------|----------------|-----------|-----------|------|------|------|------|------|------|------|------|------|------|------|------|------|------|------|------|--|
| IN-DOOR AIR-FLOW (CMH) | OUT-DOOR DB(C) | ID WB (C) | 16.0 | | | | 18.0 | | | | 19.0 | | | | 22.0 | | | | | |
| | | | ID DB (C) | 23.0 | 25.0 | 27.0 | 29.0 | 23.0 | 25.0 | 27.0 | 29.0 | 23.0 | 25.0 | 27.0 | 29.0 | 23.0 | 25.0 | 27.0 | 29.0 | |
| 330 | 18 | TC | 2.67 | 2.67 | 2.67 | 2.69 | 2.83 | 2.84 | 2.84 | 2.84 | 2.92 | 2.92 | 2.92 | 2.92 | 3.12 | 3.12 | 3.12 | 3.12 | | |
| | | S/T | 0.71 | 0.80 | 0.88 | 0.96 | 0.58 | 0.65 | 0.73 | 0.81 | 0.51 | 0.59 | 0.66 | 0.74 | 0.37 | 0.44 | 0.51 | 0.58 | | |
| | | PI | 0.56 | 0.57 | 0.57 | 0.56 | 0.56 | 0.56 | 0.56 | 0.56 | 0.56 | 0.56 | 0.56 | 0.56 | 0.56 | 0.56 | 0.56 | 0.56 | 0.56 | |
| | 25 | TC | 2.49 | 2.49 | 2.52 | 2.55 | 2.67 | 2.67 | 2.67 | 2.67 | 2.72 | 2.72 | 2.72 | 2.72 | 2.95 | 2.95 | 2.95 | 2.95 | | |
| | | S/T | 0.72 | 0.81 | 0.90 | 0.98 | 0.58 | 0.66 | 0.75 | 0.83 | 0.51 | 0.60 | 0.68 | 0.76 | 0.36 | 0.44 | 0.51 | 0.59 | | |
| | | PI | 0.64 | 0.64 | 0.64 | 0.64 | 0.64 | 0.64 | 0.64 | 0.64 | 0.64 | 0.64 | 0.64 | 0.64 | 0.64 | 0.64 | 0.64 | 0.64 | 0.64 | |
| | 30 | TC | 2.38 | 2.38 | 2.41 | 2.44 | 2.52 | 2.52 | 2.52 | 2.52 | 2.61 | 2.61 | 2.61 | 2.61 | 2.81 | 2.81 | 2.81 | 2.81 | | |
| | | S/T | 0.73 | 0.83 | 0.91 | 1.00 | 0.59 | 0.67 | 0.76 | 0.85 | 0.52 | 0.60 | 0.69 | 0.77 | 0.36 | 0.44 | 0.51 | 0.59 | | |
| | | PI | 0.71 | 0.71 | 0.71 | 0.71 | 0.71 | 0.71 | 0.71 | 0.71 | 0.71 | 0.71 | 0.71 | 0.71 | 0.71 | 0.71 | 0.71 | 0.71 | 0.71 | |
| | 35 | TC | 2.26 | 2.26 | 2.29 | 2.32 | 2.41 | 2.41 | 2.41 | 2.41 | 2.49 | 2.49 | 2.49 | 2.52 | 2.49 | 2.67 | 2.67 | 2.67 | 2.67 | |
| | | S/T | 0.74 | 0.84 | 0.93 | 1.00 | 0.59 | 0.68 | 0.77 | 0.87 | 0.52 | 0.61 | 0.69 | 0.78 | 0.35 | 0.44 | 0.52 | 0.60 | | |
| | | PI | 0.77 | 0.77 | 0.77 | 0.77 | 0.78 | 0.78 | 0.78 | 0.78 | 0.78 | 0.78 | 0.78 | 0.78 | 0.78 | 0.78 | 0.78 | 0.78 | 0.78 | |
| 40 | TC | 2.05 | 2.07 | 2.10 | 2.13 | 2.17 | 2.17 | 2.17 | 2.19 | 2.26 | 2.26 | 2.27 | 2.26 | 2.43 | 2.43 | 2.43 | 2.43 | | | |
| | S/T | 0.77 | 0.87 | 0.97 | 1.00 | 0.60 | 0.70 | 0.80 | 0.90 | 0.52 | 0.62 | 0.72 | 0.82 | 0.35 | 0.44 | 0.53 | 0.62 | | | |
| | PI | 0.88 | 0.88 | 0.88 | 0.88 | 0.89 | 0.89 | 0.89 | 0.89 | 0.89 | 0.89 | 0.89 | 0.89 | 0.89 | 0.89 | 0.89 | 0.89 | 0.89 | | |
| 43 | TC | 1.95 | 1.97 | 2.00 | 2.03 | 2.06 | 2.06 | 2.06 | 2.09 | 2.14 | 2.14 | 2.14 | 2.14 | 2.31 | 2.31 | 2.31 | 2.31 | | | |
| | S/T | 0.78 | 0.88 | 0.99 | 1.00 | 0.61 | 0.71 | 0.82 | 0.92 | 0.53 | 0.63 | 0.73 | 0.83 | 0.35 | 0.44 | 0.53 | 0.63 | | | |
| | PI | 0.94 | 0.94 | 0.94 | 0.94 | 0.95 | 0.95 | 0.95 | 0.95 | 0.95 | 0.95 | 0.95 | 0.95 | 0.96 | 0.96 | 0.96 | 0.96 | 0.96 | | |
| 460 | 18 | TC | 2.72 | 2.75 | 2.78 | 2.81 | 2.90 | 2.90 | 2.90 | 2.92 | 2.98 | 2.98 | 2.98 | 2.98 | 3.21 | 3.21 | 3.21 | 3.21 | | |
| | | S/T | 0.78 | 0.89 | 1.00 | 1.00 | 0.61 | 0.71 | 0.82 | 0.92 | 0.53 | 0.63 | 0.73 | 0.84 | 0.34 | 0.44 | 0.54 | 0.63 | | |
| | | PI | 0.58 | 0.58 | 0.58 | 0.58 | 0.58 | 0.58 | 0.58 | 0.58 | 0.58 | 0.58 | 0.58 | 0.58 | 0.57 | 0.57 | 0.57 | 0.57 | | |
| | 25 | TC | 2.55 | 2.58 | 2.61 | 2.64 | 2.72 | 2.72 | 2.72 | 2.75 | 2.81 | 2.81 | 2.81 | 2.81 | 3.01 | 3.01 | 3.01 | 3.01 | | |
| | | S/T | 0.80 | 0.92 | 1.00 | 1.00 | 0.62 | 0.73 | 0.84 | 0.95 | 0.53 | 0.64 | 0.75 | 0.86 | 0.34 | 0.44 | 0.54 | 0.65 | | |
| | | PI | 0.66 | 0.66 | 0.66 | 0.66 | 0.66 | 0.66 | 0.66 | 0.66 | 0.66 | 0.66 | 0.66 | 0.66 | 0.66 | 0.66 | 0.66 | 0.66 | 0.66 | |
| | 30 | TC | 2.44 | 2.47 | 2.49 | 2.52 | 2.58 | 2.58 | 2.58 | 2.61 | 2.67 | 2.67 | 2.67 | 2.70 | 2.87 | 2.87 | 2.87 | 2.87 | | |
| | | S/T | 0.82 | 0.94 | 1.00 | 1.00 | 0.63 | 0.75 | 0.87 | 0.98 | 0.54 | 0.65 | 0.77 | 0.88 | 0.34 | 0.44 | 0.55 | 0.66 | | |
| | | PI | 0.73 | 0.73 | 0.73 | 0.73 | 0.73 | 0.73 | 0.73 | 0.73 | 0.73 | 0.73 | 0.73 | 0.73 | 0.73 | 0.73 | 0.73 | 0.73 | 0.73 | |
| | 35 | TC | 2.32 | 2.35 | 2.38 | 2.41 | 2.47 | 2.47 | 2.47 | 2.49 | 2.55 | 2.55 | 2.58 | 2.61 | 2.75 | 2.75 | 2.75 | 2.75 | | |
| | | S/T | 0.83 | 0.96 | 1.00 | 1.00 | 0.64 | 0.76 | 0.88 | 1.00 | 0.54 | 0.66 | 0.78 | 0.90 | 0.33 | 0.45 | 0.56 | 0.67 | | |
| | | PI | 0.80 | 0.80 | 0.80 | 0.80 | 0.80 | 0.80 | 0.80 | 0.80 | 0.80 | 0.80 | 0.80 | 0.80 | 0.80 | 0.80 | 0.80 | 0.80 | 0.80 | |
| 40 | TC | 2.12 | 2.15 | 2.18 | 2.20 | 2.26 | 2.26 | 2.28 | 2.31 | 2.35 | 2.35 | 2.36 | 2.39 | 2.53 | 2.53 | 2.53 | 2.53 | | | |
| | S/T | 0.87 | 1.00 | 1.00 | 1.00 | 0.65 | 0.79 | 0.92 | 1.00 | 0.55 | 0.69 | 0.82 | 0.95 | 0.33 | 0.45 | 0.58 | 0.70 | | | |
| | PI | 0.91 | 0.91 | 0.91 | 0.91 | 0.92 | 0.92 | 0.92 | 0.92 | 0.92 | 0.92 | 0.92 | 0.92 | 0.93 | 0.93 | 0.93 | 0.93 | | | |
| 43 | TC | 2.00 | 2.03 | 2.06 | 2.09 | 2.14 | 2.14 | 2.17 | 2.20 | 2.23 | 2.23 | 2.23 | 2.26 | 2.40 | 2.40 | 2.40 | 2.40 | | | |
| | S/T | 0.89 | 1.00 | 1.00 | 1.00 | 0.66 | 0.81 | 0.94 | 1.00 | 0.56 | 0.70 | 0.83 | 0.97 | 0.33 | 0.45 | 0.58 | 0.71 | | | |
| | PI | 0.98 | 0.98 | 0.98 | 0.98 | 0.99 | 0.99 | 0.99 | 0.99 | 0.99 | 0.99 | 0.99 | 0.99 | 1.00 | 1.00 | 1.00 | 1.00 | | | |
| 530 | 18 | TC | 2.78 | 2.81 | 2.84 | 2.87 | 2.95 | 2.95 | 2.95 | 2.98 | 3.04 | 3.04 | 3.04 | 3.07 | 3.27 | 3.27 | 3.27 | 3.27 | | |
| | | S/T | 0.82 | 0.94 | 1.00 | 1.00 | 0.63 | 0.75 | 0.87 | 0.98 | 0.54 | 0.66 | 0.77 | 0.89 | 0.34 | 0.44 | 0.55 | 0.66 | | |
| | | PI | 0.60 | 0.60 | 0.60 | 0.60 | 0.59 | 0.59 | 0.59 | 0.59 | 0.59 | 0.59 | 0.59 | 0.59 | 0.59 | 0.59 | 0.59 | 0.59 | 0.59 | |
| | 25 | TC | 2.61 | 2.64 | 2.67 | 2.70 | 2.78 | 2.78 | 2.81 | 2.84 | 2.87 | 2.87 | 2.87 | 2.90 | 3.07 | 3.07 | 3.07 | 3.07 | | |
| | | S/T | 0.84 | 0.97 | 1.00 | 1.00 | 0.64 | 0.77 | 0.89 | 1.00 | 0.55 | 0.67 | 0.79 | 0.91 | 0.33 | 0.45 | 0.56 | 0.68 | | |
| | | PI | 0.68 | 0.68 | 0.68 | 0.68 | 0.68 | 0.68 | 0.68 | 0.68 | 0.68 | 0.68 | 0.68 | 0.68 | 0.68 | 0.68 | 0.68 | 0.68 | 0.68 | |
| | 30 | TC | 2.49 | 2.52 | 2.55 | 2.58 | 2.64 | 2.64 | 2.67 | 2.70 | 2.72 | 2.72 | 2.72 | 2.75 | 2.95 | 2.95 | 2.95 | 2.95 | | |
| | | S/T | 0.86 | 0.99 | 1.00 | 1.00 | 0.65 | 0.78 | 0.91 | 1.00 | 0.55 | 0.68 | 0.81 | 0.94 | 0.33 | 0.45 | 0.57 | 0.69 | | |
| | | PI | 0.74 | 0.74 | 0.74 | 0.74 | 0.74 | 0.74 | 0.74 | 0.74 | 0.75 | 0.75 | 0.75 | 0.75 | 0.75 | 0.75 | 0.75 | 0.75 | 0.75 | |
| | 35 | TC | 2.38 | 2.41 | 2.44 | 2.47 | 2.52 | 2.52 | 2.55 | 2.58 | 2.61 | 2.61 | 2.64 | 2.67 | 2.81 | 2.81 | 2.81 | 2.81 | | |
| | | S/T | 0.88 | 1.00 | 1.00 | 1.00 | 0.66 | 0.80 | 0.93 | 1.00 | 0.56 | 0.69 | 0.83 | 0.95 | 0.33 | 0.45 | 0.58 | 0.71 | | |
| | | PI | 0.81 | 0.81 | 0.81 | 0.81 | 0.82 | 0.82 | 0.82 | 0.82 | 0.82 | 0.82 | 0.82 | 0.82 | 0.82 | 0.82 | 0.82 | 0.82 | 0.82 | |
| 40 | TC | 2.18 | 2.20 | 2.23 | 2.26 | 2.32 | 2.32 | 2.35 | 2.38 | 2.39 | 2.39 | 2.42 | 2.44 | 2.59 | 2.59 | 2.59 | 2.59 | | | |
| | S/T | 0.92 | 1.00 | 1.00 | 1.00 | 0.68 | 0.84 | 0.98 | 1.00 | 0.57 | 0.72 | 0.87 | 1.00 | 0.32 | 0.46 | 0.60 | 0.90 | | | |
| | PI | 0.93 | 0.93 | 0.93 | 0.93 | 0.94 | 0.94 | 0.94 | 0.94 | 0.94 | 0.94 | 0.94 | 0.94 | 0.95 | 0.95 | 0.95 | 0.95 | | | |
| 43 | TC | 2.06 | 2.09 | 2.12 | 2.14 | 2.20 | 2.20 | 2.23 | 2.26 | 2.26 | 2.26 | 2.29 | 2.32 | 2.46 | 2.46 | 2.46 | 2.46 | | | |
| | S/T | 0.94 | 1.00 | 1.00 | 1.00 | 0.69 | 0.85 | 1.00 | 1.00 | 0.58 | 0.74 | 0.89 | 1.00 | 0.32 | 0.46 | 0.61 | 0.92 | | | |
| | PI | 1.00 | 1.00 | 1.00 | 1.00 | 1.01 | 1.01 | 1.01 | 1.01 | 1.01 | 1.01 | 1.01 | 1.01 | 1.01 | 1.02 | 1.02 | 1.02 | 1.02 | | |

TC:Total Cooling Capacity (kW)

S/T:Sensible Cooling Capacity Ratio

PI:Power Input(kW)

| KSGA35HFRN1 / KSRA35HFRN1 | | | | | | | | | | | | | | | | | | | | |
|---------------------------|-----------------|------------|------------|------|------|------|------|------|------|------|------|------|------|------|------|------|------|------|------|--|
| IN-DOOR AIR-FLOW (CMH) | OUT-DOOR DB(°C) | ID WB (°C) | 16.0 | | | | 18.0 | | | | 19.0 | | | | 22.0 | | | | | |
| | | | ID DB (°C) | 23.0 | 25.0 | 27.0 | 29.0 | 23.0 | 25.0 | 27.0 | 29.0 | 23.0 | 25.0 | 27.0 | 29.0 | 23.0 | 25.0 | 27.0 | 29.0 | |
| 360 | 18 | TC | 3.60 | 3.60 | 3.60 | 3.60 | 3.82 | 3.80 | 3.80 | 3.80 | 3.92 | 3.92 | 3.92 | 3.92 | 4.21 | 4.21 | 4.21 | 4.21 | | |
| | | S/T | 0.69 | 0.75 | 0.82 | 0.89 | 0.57 | 0.63 | 0.70 | 0.76 | 0.51 | 0.57 | 0.64 | 0.70 | 0.38 | 0.44 | 0.50 | 0.56 | | |
| | | PI | 0.75 | 0.75 | 0.75 | 0.75 | 0.75 | 0.75 | 0.75 | 0.75 | 0.75 | 0.75 | 0.75 | 0.75 | 0.74 | 0.74 | 0.74 | 0.74 | | |
| | 25 | TC | 3.37 | 3.37 | 3.37 | 3.40 | 3.57 | 3.57 | 3.57 | 3.57 | 3.69 | 3.69 | 3.69 | 3.69 | 3.98 | 3.98 | 3.98 | 3.98 | | |
| | | S/T | 0.69 | 0.76 | 0.84 | 0.91 | 0.57 | 0.64 | 0.71 | 0.77 | 0.51 | 0.58 | 0.64 | 0.71 | 0.38 | 0.44 | 0.50 | 0.56 | | |
| | | PI | 0.87 | 0.87 | 0.87 | 0.87 | 0.87 | 0.87 | 0.87 | 0.87 | 0.87 | 0.87 | 0.87 | 0.87 | 0.87 | 0.87 | 0.87 | 0.87 | 0.87 | |
| | 30 | TC | 3.20 | 3.20 | 3.20 | 3.23 | 3.43 | 3.43 | 3.43 | 3.43 | 3.52 | 3.52 | 3.52 | 3.52 | 3.80 | 3.80 | 3.80 | 3.80 | | |
| | | S/T | 0.70 | 0.77 | 0.85 | 0.92 | 0.57 | 0.64 | 0.71 | 0.78 | 0.51 | 0.58 | 0.65 | 0.72 | 0.38 | 0.44 | 0.50 | 0.57 | | |
| | | PI | 0.95 | 0.95 | 0.95 | 0.95 | 0.95 | 0.95 | 0.95 | 0.95 | 0.95 | 0.95 | 0.95 | 0.95 | 0.96 | 0.96 | 0.96 | 0.96 | | |
| | 35 | TC | 3.05 | 3.05 | 3.05 | 3.08 | 3.26 | 3.26 | 3.26 | 3.26 | 3.34 | 3.34 | 3.34 | 3.34 | 3.60 | 3.60 | 3.60 | 3.60 | | |
| | | S/T | 0.71 | 0.79 | 0.86 | 0.94 | 0.57 | 0.65 | 0.72 | 0.80 | 0.51 | 0.58 | 0.65 | 0.73 | 0.37 | 0.44 | 0.50 | 0.57 | | |
| | | PI | 1.04 | 1.04 | 1.04 | 1.04 | 1.05 | 1.05 | 1.05 | 1.05 | 1.05 | 1.05 | 1.05 | 1.05 | 1.06 | 1.06 | 1.06 | 1.06 | | |
| | 40 | TC | 2.82 | 2.82 | 2.84 | 2.87 | 3.03 | 3.03 | 3.03 | 3.03 | 3.11 | 3.11 | 3.13 | 3.11 | 3.36 | 3.36 | 3.36 | 3.36 | | |
| | | S/T | 0.72 | 0.81 | 0.89 | 0.98 | 0.58 | 0.66 | 0.74 | 0.82 | 0.51 | 0.59 | 0.67 | 0.75 | 0.36 | 0.44 | 0.51 | 0.58 | | |
| | | PI | 1.18 | 1.18 | 1.18 | 1.18 | 1.19 | 1.19 | 1.19 | 1.19 | 1.19 | 1.19 | 1.19 | 1.19 | 1.20 | 1.20 | 1.20 | 1.20 | | |
| | 43 | TC | 2.67 | 2.67 | 2.70 | 2.73 | 2.87 | 2.87 | 2.87 | 2.87 | 2.96 | 2.96 | 2.96 | 2.96 | 3.19 | 3.19 | 3.19 | 3.19 | | |
| | | S/T | 0.73 | 0.82 | 0.91 | 0.99 | 0.58 | 0.67 | 0.75 | 0.84 | 0.52 | 0.60 | 0.68 | 0.76 | 0.36 | 0.44 | 0.51 | 0.59 | | |
| | | PI | 1.27 | 1.27 | 1.27 | 1.27 | 1.28 | 1.28 | 1.28 | 1.28 | 1.28 | 1.28 | 1.28 | 1.28 | 1.29 | 1.29 | 1.29 | 1.29 | | |
| | 480 | 18 | TC | 3.66 | 3.66 | 3.69 | 3.72 | 3.89 | 3.89 | 3.89 | 3.89 | 4.01 | 4.01 | 4.01 | 4.01 | 4.30 | 4.30 | 4.30 | 4.30 | |
| | | | S/T | 0.72 | 0.81 | 0.90 | 0.98 | 0.58 | 0.66 | 0.75 | 0.83 | 0.51 | 0.60 | 0.68 | 0.76 | 0.36 | 0.44 | 0.51 | 0.59 | |
| | | | PI | 0.77 | 0.77 | 0.77 | 0.77 | 0.77 | 0.77 | 0.77 | 0.77 | 0.77 | 0.76 | 0.76 | 0.76 | 0.76 | 0.76 | 0.76 | 0.76 | |
| | | 25 | TC | 3.43 | 3.43 | 3.46 | 3.49 | 3.63 | 3.63 | 3.63 | 3.63 | 3.75 | 3.75 | 3.75 | 3.75 | 4.04 | 4.04 | 4.04 | 4.04 | |
| | | | S/T | 0.74 | 0.83 | 0.92 | 1.00 | 0.59 | 0.68 | 0.77 | 0.85 | 0.52 | 0.60 | 0.69 | 0.78 | 0.36 | 0.44 | 0.52 | 0.60 | |
| | | | PI | 0.89 | 0.89 | 0.89 | 0.89 | 0.89 | 0.89 | 0.89 | 0.89 | 0.89 | 0.89 | 0.89 | 0.89 | 0.89 | 0.89 | 0.89 | 0.89 | |
| 30 | | TC | 3.26 | 3.26 | 3.29 | 3.32 | 3.49 | 3.49 | 3.49 | 3.49 | 3.57 | 3.57 | 3.57 | 3.57 | 3.86 | 3.86 | 3.86 | 3.86 | | |
| | | S/T | 0.75 | 0.85 | 0.94 | 1.00 | 0.59 | 0.68 | 0.78 | 0.87 | 0.52 | 0.61 | 0.70 | 0.79 | 0.35 | 0.44 | 0.52 | 0.60 | | |
| | | PI | 0.97 | 0.97 | 0.97 | 0.97 | 0.98 | 0.98 | 0.98 | 0.98 | 0.98 | 0.98 | 0.98 | 0.98 | 0.98 | 0.98 | 0.98 | 0.98 | | |
| 35 | | TC | 3.11 | 3.11 | 3.14 | 3.17 | 3.32 | 3.32 | 3.32 | 3.34 | 3.40 | 3.40 | 3.46 | 3.40 | 3.66 | 3.66 | 3.66 | 3.66 | | |
| | | S/T | 0.76 | 0.86 | 0.96 | 1.00 | 0.60 | 0.69 | 0.79 | 0.89 | 0.52 | 0.62 | 0.71 | 0.81 | 0.35 | 0.44 | 0.53 | 0.61 | | |
| | | PI | 1.07 | 1.07 | 1.07 | 1.07 | 1.07 | 1.07 | 1.07 | 1.07 | 1.07 | 1.07 | 1.07 | 1.07 | 1.07 | 1.07 | 1.07 | 1.07 | | |
| 40 | | TC | 2.83 | 2.84 | 2.87 | 2.90 | 3.01 | 3.01 | 3.01 | 3.04 | 3.09 | 3.09 | 3.11 | 3.09 | 3.35 | 3.35 | 3.35 | 3.35 | | |
| | | S/T | 0.79 | 0.90 | 1.00 | 1.00 | 0.61 | 0.72 | 0.83 | 0.93 | 0.53 | 0.63 | 0.74 | 0.84 | 0.34 | 0.44 | 0.54 | 0.63 | | |
| | | PI | 1.21 | 1.21 | 1.21 | 1.21 | 1.22 | 1.22 | 1.22 | 1.22 | 1.22 | 1.22 | 1.22 | 1.22 | 1.23 | 1.23 | 1.23 | 1.23 | | |
| 43 | | TC | 2.68 | 2.71 | 2.73 | 2.76 | 2.85 | 2.85 | 2.85 | 2.88 | 2.93 | 2.93 | 2.93 | 2.93 | 3.19 | 3.19 | 3.19 | 3.19 | | |
| | | S/T | 0.80 | 0.91 | 1.00 | 1.00 | 0.62 | 0.73 | 0.84 | 0.95 | 0.53 | 0.64 | 0.75 | 0.86 | 0.34 | 0.44 | 0.54 | 0.64 | | |
| | | PI | 1.30 | 1.30 | 1.30 | 1.30 | 1.31 | 1.31 | 1.31 | 1.31 | 1.31 | 1.31 | 1.31 | 1.31 | 1.33 | 1.33 | 1.33 | 1.33 | | |
| 560 | | 18 | TC | 3.72 | 3.72 | 3.75 | 3.78 | 3.95 | 3.95 | 3.95 | 3.95 | 4.06 | 4.06 | 4.06 | 4.06 | 4.35 | 4.35 | 4.35 | 4.35 | |
| | | | S/T | 0.75 | 0.85 | 0.95 | 1.00 | 0.59 | 0.69 | 0.79 | 0.88 | 0.52 | 0.61 | 0.71 | 0.80 | 0.35 | 0.44 | 0.52 | 0.61 | |
| | | | PI | 0.79 | 0.79 | 0.79 | 0.79 | 0.78 | 0.78 | 0.78 | 0.78 | 0.78 | 0.78 | 0.78 | 0.78 | 0.78 | 0.78 | 0.78 | 0.78 | |
| | | 25 | TC | 3.49 | 3.49 | 3.52 | 3.55 | 3.69 | 3.69 | 3.69 | 3.72 | 3.81 | 3.81 | 3.81 | 3.81 | 4.09 | 4.09 | 4.09 | 4.09 | |
| | | | S/T | 0.77 | 0.88 | 0.98 | 1.00 | 0.60 | 0.71 | 0.81 | 0.91 | 0.53 | 0.62 | 0.72 | 0.82 | 0.35 | 0.44 | 0.53 | 0.62 | |
| | | | PI | 0.91 | 0.91 | 0.91 | 0.91 | 0.91 | 0.91 | 0.91 | 0.91 | 0.91 | 0.91 | 0.91 | 0.91 | 0.91 | 0.91 | 0.91 | 0.91 | |
| | 30 | TC | 3.32 | 3.34 | 3.37 | 3.40 | 3.55 | 3.55 | 3.55 | 3.57 | 3.63 | 3.63 | 3.63 | 3.63 | 3.92 | 3.92 | 3.92 | 3.92 | | |
| | | S/T | 0.78 | 0.89 | 1.00 | 1.00 | 0.61 | 0.71 | 0.82 | 0.92 | 0.53 | 0.63 | 0.74 | 0.84 | 0.34 | 0.44 | 0.54 | 0.63 | | |
| | | PI | 1.00 | 1.00 | 1.00 | 1.00 | 1.00 | 1.00 | 1.00 | 1.00 | 1.00 | 1.00 | 1.00 | 1.00 | 1.00 | 1.00 | 1.00 | 1.00 | | |
| | 35 | TC | 3.14 | 3.17 | 3.20 | 3.23 | 3.37 | 3.37 | 3.37 | 3.40 | 3.46 | 3.46 | 3.52 | 3.46 | 3.75 | 3.75 | 3.75 | 3.75 | | |
| | | S/T | 0.80 | 0.92 | 1.00 | 1.00 | 0.62 | 0.73 | 0.84 | 0.95 | 0.53 | 0.64 | 0.75 | 0.86 | 0.34 | 0.44 | 0.54 | 0.64 | | |
| | | PI | 1.09 | 1.09 | 1.09 | 1.09 | 1.10 | 1.10 | 1.10 | 1.10 | 1.10 | 1.10 | 1.10 | 1.10 | 1.10 | 1.10 | 1.10 | 1.10 | | |
| | 40 | TC | 2.86 | 2.88 | 2.91 | 2.94 | 3.07 | 3.07 | 3.08 | 3.11 | 3.15 | 3.15 | 3.17 | 3.17 | 3.42 | 3.42 | 3.42 | 3.42 | | |
| | | S/T | 0.83 | 0.95 | 1.00 | 1.00 | 0.63 | 0.76 | 0.88 | 1.00 | 0.54 | 0.66 | 0.78 | 0.89 | 0.33 | 0.45 | 0.56 | 0.90 | | |
| | | PI | 1.24 | 1.24 | 1.24 | 1.24 | 1.25 | 1.25 | 1.25 | 1.25 | 1.25 | 1.25 | 1.25 | 1.25 | 1.26 | 1.26 | 1.26 | 1.26 | | |
| | 43 | TC | 2.71 | 2.73 | 2.76 | 2.79 | 2.90 | 2.90 | 2.93 | 2.96 | 2.99 | 2.99 | 2.99 | 3.02 | 3.25 | 3.25 | 3.25 | 3.25 | | |
| | | S/T | 0.85 | 0.98 | 1.00 | 1.00 | 0.64 | 0.77 | 0.89 | 1.00 | 0.55 | 0.67 | 0.80 | 0.92 | 0.33 | 0.45 | 0.56 | 0.92 | | |
| | | PI | 1.33 | 1.33 | 1.33 | 1.33 | 1.34 | 1.34 | 1.34 | 1.34 | 1.34 | 1.34 | 1.34 | 1.34 | 1.36 | 1.36 | 1.36 | 1.36 | | |

TC:Total Cooling Capacity (kW)

S/T:Sensible Cooling Capacity Ratio

PI:Power Input(kW)

| KSGA53HFRN1 / KSRA53HFRN1 | | | | | | | | | | | | | | | | | | |
|---------------------------|----------------|-----------|-----------|------|------|------|------|------|------|------|------|------|------|------|------|------|------|------|
| IN-DOOR AIR-FLOW (CMH) | OUT-DOOR DB(C) | ID WB (C) | 16.0 | | | | 18.0 | | | | 19.0 | | | | 22.0 | | | |
| | | | ID DB (C) | 23.0 | 25.0 | 27.0 | 29.0 | 23.0 | 25.0 | 27.0 | 29.0 | 23.0 | 25.0 | 27.0 | 29.0 | 23.0 | 25.0 | 27.0 |
| 543 | 18 | TC | 5.34 | 5.33 | 5.33 | 5.39 | 5.66 | 5.67 | 5.67 | 5.67 | 5.82 | 5.82 | 5.82 | 5.82 | 6.25 | 6.25 | 6.25 | 6.25 |
| | | S/T | 0.69 | 0.76 | 0.82 | 0.89 | 0.57 | 0.63 | 0.70 | 0.76 | 0.51 | 0.58 | 0.64 | 0.70 | 0.38 | 0.44 | 0.50 | 0.56 |
| | | PI | 1.14 | 1.14 | 1.14 | 1.14 | 1.14 | 1.14 | 1.14 | 1.14 | 1.13 | 1.13 | 1.13 | 1.13 | 1.12 | 1.12 | 1.12 | 1.12 |
| | 25 | TC | 4.99 | 4.99 | 4.99 | 5.04 | 5.30 | 5.30 | 5.30 | 5.30 | 5.47 | 5.47 | 5.47 | 5.47 | 5.87 | 5.87 | 5.87 | 5.87 |
| | | S/T | 0.69 | 0.77 | 0.84 | 0.91 | 0.57 | 0.64 | 0.71 | 0.78 | 0.51 | 0.58 | 0.64 | 0.71 | 0.38 | 0.44 | 0.50 | 0.56 |
| | | PI | 1.30 | 1.30 | 1.30 | 1.30 | 1.30 | 1.30 | 1.30 | 1.30 | 1.30 | 1.30 | 1.30 | 1.30 | 1.31 | 1.31 | 1.31 | 1.31 |
| | 30 | TC | 4.76 | 4.76 | 4.76 | 4.81 | 5.07 | 5.07 | 5.07 | 5.07 | 5.22 | 5.22 | 5.22 | 5.22 | 5.62 | 5.62 | 5.62 | 5.62 |
| | | S/T | 0.70 | 0.78 | 0.85 | 0.93 | 0.57 | 0.64 | 0.71 | 0.79 | 0.51 | 0.58 | 0.65 | 0.72 | 0.37 | 0.44 | 0.50 | 0.57 |
| | | PI | 1.43 | 1.43 | 1.43 | 1.43 | 1.43 | 1.43 | 1.43 | 1.43 | 1.44 | 1.44 | 1.44 | 1.44 | 1.44 | 1.44 | 1.44 | 1.44 |
| | 35 | TC | 4.53 | 4.53 | 4.53 | 4.59 | 4.81 | 4.81 | 4.81 | 4.81 | 4.96 | 4.96 | 4.96 | 4.96 | 5.36 | 5.36 | 5.36 | 5.36 |
| | | S/T | 0.71 | 0.79 | 0.87 | 0.94 | 0.57 | 0.65 | 0.73 | 0.80 | 0.51 | 0.59 | 0.66 | 0.73 | 0.37 | 0.44 | 0.50 | 0.57 |
| | | PI | 1.57 | 1.57 | 1.57 | 1.57 | 1.57 | 1.57 | 1.57 | 1.57 | 1.58 | 1.58 | 1.58 | 1.58 | 1.59 | 1.59 | 1.59 | 1.59 |
| | 40 | TC | 4.18 | 4.18 | 4.20 | 4.24 | 4.45 | 4.45 | 4.45 | 4.45 | 4.59 | 4.59 | 4.63 | 4.59 | 4.96 | 4.96 | 4.96 | 4.96 |
| | | S/T | 0.72 | 0.81 | 0.90 | 0.98 | 0.58 | 0.66 | 0.75 | 0.83 | 0.51 | 0.59 | 0.67 | 0.76 | 0.36 | 0.44 | 0.51 | 0.58 |
| | | PI | 1.79 | 1.79 | 1.79 | 1.79 | 1.79 | 1.79 | 1.79 | 1.79 | 1.80 | 1.80 | 1.80 | 1.80 | 1.81 | 1.81 | 1.81 | 1.81 |
| | 43 | TC | 3.97 | 3.97 | 4.00 | 4.02 | 4.22 | 4.22 | 4.22 | 4.22 | 4.37 | 4.37 | 4.37 | 4.37 | 4.71 | 4.71 | 4.71 | 4.71 |
| | | S/T | 0.73 | 0.82 | 0.91 | 1.00 | 0.58 | 0.67 | 0.76 | 0.84 | 0.52 | 0.60 | 0.68 | 0.77 | 0.36 | 0.44 | 0.51 | 0.59 |
| | | PI | 1.92 | 1.92 | 1.92 | 1.92 | 1.93 | 1.93 | 1.93 | 1.93 | 1.94 | 1.94 | 1.94 | 1.94 | 1.95 | 1.95 | 1.95 | 1.95 |
| 619 | 18 | TC | 5.48 | 5.48 | 5.48 | 5.53 | 5.79 | 5.79 | 5.79 | 5.79 | 5.96 | 5.96 | 5.96 | 5.96 | 6.39 | 6.39 | 6.39 | 6.39 |
| | | S/T | 0.70 | 0.77 | 0.85 | 0.92 | 0.57 | 0.64 | 0.71 | 0.79 | 0.51 | 0.58 | 0.65 | 0.72 | 0.37 | 0.44 | 0.50 | 0.57 |
| | | PI | 1.16 | 1.16 | 1.16 | 1.16 | 1.15 | 1.15 | 1.15 | 1.15 | 1.15 | 1.15 | 1.15 | 1.15 | 1.14 | 1.14 | 1.14 | 1.14 |
| | 25 | TC | 5.10 | 5.10 | 5.10 | 5.16 | 5.42 | 5.42 | 5.42 | 5.42 | 5.59 | 5.59 | 5.59 | 5.59 | 6.02 | 6.02 | 6.02 | 6.02 |
| | | S/T | 0.71 | 0.79 | 0.87 | 0.95 | 0.58 | 0.65 | 0.73 | 0.80 | 0.51 | 0.59 | 0.66 | 0.73 | 0.37 | 0.44 | 0.51 | 0.57 |
| | | PI | 1.33 | 1.33 | 1.33 | 1.33 | 1.33 | 1.33 | 1.33 | 1.33 | 1.33 | 1.33 | 1.33 | 1.33 | 1.33 | 1.33 | 1.33 | 1.33 |
| | 30 | TC | 4.87 | 4.87 | 4.93 | 4.99 | 5.19 | 5.19 | 5.19 | 5.19 | 5.33 | 5.33 | 5.33 | 5.33 | 5.76 | 5.76 | 5.76 | 5.76 |
| | | S/T | 0.72 | 0.80 | 0.88 | 0.96 | 0.58 | 0.66 | 0.74 | 0.82 | 0.51 | 0.59 | 0.67 | 0.75 | 0.36 | 0.44 | 0.51 | 0.58 |
| | | PI | 1.46 | 1.46 | 1.46 | 1.46 | 1.46 | 1.46 | 1.46 | 1.46 | 1.47 | 1.47 | 1.47 | 1.47 | 1.47 | 1.47 | 1.47 | 1.47 |
| | 35 | TC | 4.62 | 4.62 | 4.67 | 4.73 | 4.93 | 4.93 | 4.93 | 4.93 | 5.07 | 5.07 | 5.16 | 5.07 | 5.48 | 5.48 | 5.48 | 5.48 |
| | | S/T | 0.73 | 0.82 | 0.90 | 0.99 | 0.58 | 0.67 | 0.75 | 0.83 | 0.52 | 0.60 | 0.67 | 0.76 | 0.36 | 0.44 | 0.51 | 0.59 |
| | | PI | 1.59 | 1.59 | 1.59 | 1.59 | 1.60 | 1.60 | 1.60 | 1.60 | 1.60 | 1.60 | 1.61 | 1.60 | 1.60 | 1.60 | 1.60 | 1.60 |
| | 40 | TC | 4.19 | 4.19 | 4.23 | 4.27 | 4.47 | 4.47 | 4.47 | 4.50 | 4.61 | 4.61 | 4.64 | 4.61 | 4.98 | 4.98 | 4.98 | 4.98 |
| | | S/T | 0.75 | 0.84 | 0.94 | 1.00 | 0.59 | 0.68 | 0.77 | 0.87 | 0.52 | 0.61 | 0.70 | 0.79 | 0.35 | 0.44 | 0.52 | 0.60 |
| | | PI | 1.83 | 1.83 | 1.83 | 1.83 | 1.83 | 1.83 | 1.83 | 1.83 | 1.84 | 1.84 | 1.84 | 1.84 | 1.85 | 1.85 | 1.85 | 1.85 |
| | 43 | TC | 3.98 | 3.98 | 4.01 | 4.03 | 4.23 | 4.23 | 4.23 | 4.29 | 4.37 | 4.37 | 4.37 | 4.37 | 4.74 | 4.74 | 4.74 | 4.74 |
| | | S/T | 0.76 | 0.86 | 0.96 | 1.00 | 0.60 | 0.69 | 0.79 | 0.88 | 0.52 | 0.61 | 0.71 | 0.80 | 0.35 | 0.44 | 0.52 | 0.61 |
| | | PI | 1.96 | 1.96 | 1.96 | 1.96 | 1.97 | 1.97 | 1.97 | 1.97 | 1.98 | 1.98 | 1.98 | 1.98 | 1.99 | 1.99 | 1.99 | 1.99 |
| 822 | 18 | TC | 5.59 | 5.59 | 5.65 | 5.71 | 5.93 | 5.93 | 5.93 | 5.93 | 6.08 | 6.08 | 6.08 | 6.08 | 6.54 | 6.54 | 6.54 | 6.54 |
| | | S/T | 0.75 | 0.84 | 0.94 | 1.00 | 0.59 | 0.68 | 0.78 | 0.87 | 0.52 | 0.61 | 0.70 | 0.79 | 0.35 | 0.44 | 0.52 | 0.61 |
| | | PI | 1.18 | 1.18 | 1.18 | 1.18 | 1.18 | 1.18 | 1.18 | 1.18 | 1.17 | 1.17 | 1.17 | 1.17 | 1.16 | 1.16 | 1.16 | 1.16 |
| | 25 | TC | 5.22 | 5.22 | 5.28 | 5.33 | 5.56 | 5.56 | 5.56 | 5.62 | 5.73 | 5.73 | 5.73 | 5.73 | 6.16 | 6.16 | 6.16 | 6.16 |
| | | S/T | 0.76 | 0.87 | 0.97 | 1.00 | 0.60 | 0.70 | 0.80 | 0.89 | 0.52 | 0.62 | 0.71 | 0.81 | 0.35 | 0.44 | 0.53 | 0.62 |
| | | PI | 1.36 | 1.36 | 1.36 | 1.36 | 1.36 | 1.36 | 1.36 | 1.36 | 1.36 | 1.36 | 1.36 | 1.36 | 1.36 | 1.36 | 1.36 | 1.36 |
| | 30 | TC | 4.99 | 5.05 | 5.10 | 5.16 | 5.30 | 5.30 | 5.30 | 5.36 | 5.45 | 5.45 | 5.45 | 5.45 | 5.88 | 5.88 | 5.88 | 5.88 |
| | | S/T | 0.77 | 0.88 | 0.98 | 1.00 | 0.61 | 0.71 | 0.81 | 0.91 | 0.53 | 0.63 | 0.73 | 0.83 | 0.35 | 0.44 | 0.53 | 0.63 |
| | | PI | 1.50 | 1.50 | 1.50 | 1.50 | 1.50 | 1.50 | 1.50 | 1.50 | 1.50 | 1.50 | 1.50 | 1.50 | 1.51 | 1.51 | 1.51 | 1.51 |
| | 35 | TC | 4.73 | 4.79 | 4.85 | 4.90 | 5.05 | 5.05 | 5.05 | 5.10 | 5.19 | 5.19 | 5.28 | 5.19 | 5.59 | 5.59 | 5.59 | 5.59 |
| | | S/T | 0.79 | 0.90 | 1.00 | 1.00 | 0.61 | 0.72 | 0.83 | 0.93 | 0.53 | 0.64 | 0.74 | 0.85 | 0.34 | 0.44 | 0.54 | 0.64 |
| | | PI | 1.63 | 1.63 | 1.63 | 1.63 | 1.63 | 1.63 | 1.63 | 1.63 | 1.64 | 1.64 | 1.64 | 1.64 | 1.65 | 1.65 | 1.65 | 1.65 |
| | 40 | TC | 4.29 | 4.32 | 4.36 | 4.40 | 4.58 | 4.58 | 4.58 | 4.63 | 4.72 | 4.72 | 4.75 | 4.75 | 5.10 | 5.10 | 5.10 | 5.10 |
| | | S/T | 0.82 | 0.94 | 1.00 | 1.00 | 0.63 | 0.75 | 0.87 | 0.98 | 0.54 | 0.66 | 0.77 | 0.88 | 0.34 | 0.44 | 0.55 | 0.90 |
| | | PI | 1.87 | 1.87 | 1.87 | 1.87 | 1.88 | 1.88 | 1.88 | 1.88 | 1.88 | 1.88 | 1.88 | 1.88 | 1.90 | 1.90 | 1.90 | 1.90 |
| | 43 | TC | 4.06 | 4.09 | 4.12 | 4.15 | 4.35 | 4.35 | 4.35 | 4.40 | 4.49 | 4.49 | 4.49 | 4.54 | 4.85 | 4.85 | 4.85 | 4.85 |
| | | S/T | 0.83 | 0.96 | 1.00 | 1.00 | 0.63 | 0.76 | 0.88 | 1.00 | 0.54 | 0.66 | 0.78 | 0.90 | 0.33 | 0.45 | 0.56 | 0.92 |
| | | PI | 2.01 | 2.01 | 2.01 | 2.01 | 2.02 | 2.02 | 2.02 | 2.02 | 2.02 | 2.02 | 2.02 | 2.02 | 2.04 | 2.04 | 2.04 | 2.04 |

TC:Total Cooling Capacity (kW)

S/T:Sensible Cooling Capacity Ratio

PI:Power Input(kW)

| KSGA70HFRN1 / KSRA70HFRN1 | | | | | | | | | | | | | | | | | | | | |
|---------------------------|----------------|-----------|-----------|------|------|------|------|------|------|------|------|------|------|------|------|------|------|------|------|------|
| IN-DOOR AIR-FLOW (CMH) | OUT-DOOR DB(C) | ID WB (C) | 16.0 | | | | 18.0 | | | | 19.0 | | | | 22.0 | | | | | |
| | | | ID DB (C) | 23.0 | 25.0 | 27.0 | 29.0 | 23.0 | 25.0 | 27.0 | 29.0 | 23.0 | 25.0 | 27.0 | 29.0 | 23.0 | 25.0 | 27.0 | 29.0 | |
| 860 | 18 | TC | 7.14 | 7.15 | 7.15 | 7.20 | 7.57 | 7.58 | 7.58 | 7.58 | 7.78 | 7.78 | 7.78 | 7.78 | 8.35 | 8.35 | 8.35 | 8.35 | | |
| | | S/T | 0.71 | 0.79 | 0.87 | 0.95 | 0.58 | 0.65 | 0.73 | 0.80 | 0.51 | 0.59 | 0.66 | 0.73 | 0.37 | 0.44 | 0.51 | 0.57 | | |
| | | PI | 1.52 | 1.52 | 1.52 | 1.52 | 1.51 | 1.51 | 1.51 | 1.51 | 1.51 | 1.51 | 1.51 | 1.51 | 1.50 | 1.50 | 1.50 | 1.50 | | |
| | 25 | TC | 6.69 | 6.69 | 6.74 | 6.80 | 7.09 | 7.09 | 7.09 | 7.09 | 7.32 | 7.32 | 7.32 | 7.32 | 7.86 | 7.86 | 7.86 | 7.86 | | |
| | | S/T | 0.72 | 0.81 | 0.89 | 0.97 | 0.58 | 0.66 | 0.74 | 0.82 | 0.51 | 0.59 | 0.67 | 0.75 | 0.36 | 0.44 | 0.51 | 0.58 | | |
| | | PI | 1.75 | 1.75 | 1.75 | 1.75 | 1.75 | 1.75 | 1.75 | 1.75 | 1.75 | 1.75 | 1.75 | 1.75 | 1.75 | 1.75 | 1.75 | 1.75 | 1.75 | |
| | 30 | TC | 6.37 | 6.37 | 6.43 | 6.49 | 6.77 | 6.77 | 6.77 | 6.77 | 6.97 | 6.97 | 6.97 | 6.97 | 7.52 | 7.52 | 7.52 | 7.52 | | |
| | | S/T | 0.73 | 0.82 | 0.91 | 0.99 | 0.58 | 0.67 | 0.75 | 0.84 | 0.52 | 0.60 | 0.68 | 0.76 | 0.36 | 0.44 | 0.51 | 0.59 | | |
| | | PI | 1.91 | 1.91 | 1.91 | 1.91 | 1.92 | 1.92 | 1.92 | 1.92 | 1.92 | 1.92 | 1.92 | 1.92 | 1.93 | 1.93 | 1.93 | 1.93 | 1.93 | |
| | 35 | TC | 6.06 | 6.06 | 6.11 | 6.17 | 6.43 | 6.43 | 6.43 | 6.43 | 6.63 | 6.63 | 6.63 | 6.63 | 7.17 | 7.17 | 7.17 | 7.17 | | |
| | | S/T | 0.74 | 0.83 | 0.93 | 1.00 | 0.59 | 0.68 | 0.77 | 0.86 | 0.52 | 0.60 | 0.69 | 0.78 | 0.36 | 0.44 | 0.52 | 0.60 | | |
| | | PI | 2.09 | 2.09 | 2.09 | 2.09 | 2.10 | 2.10 | 2.10 | 2.10 | 2.11 | 2.11 | 2.11 | 2.11 | 2.12 | 2.12 | 2.12 | 2.12 | 2.12 | |
| | 40 | TC | 5.58 | 5.58 | 5.64 | 5.69 | 5.94 | 5.94 | 5.94 | 5.97 | 6.14 | 6.14 | 6.14 | 6.14 | 6.63 | 6.63 | 6.63 | 6.63 | | |
| | | S/T | 0.76 | 0.87 | 0.97 | 1.00 | 0.60 | 0.70 | 0.80 | 0.89 | 0.52 | 0.62 | 0.71 | 0.81 | 0.35 | 0.44 | 0.53 | 0.61 | | |
| | | PI | 2.39 | 2.39 | 2.39 | 2.39 | 2.40 | 2.40 | 2.40 | 2.40 | 2.41 | 2.41 | 2.41 | 2.41 | 2.43 | 2.43 | 2.43 | 2.43 | 2.43 | |
| | 43 | TC | 5.29 | 5.29 | 5.35 | 5.40 | 5.63 | 5.63 | 5.63 | 5.69 | 5.83 | 5.83 | 5.83 | 5.83 | 6.29 | 6.29 | 6.29 | 6.29 | | |
| | | S/T | 0.77 | 0.88 | 0.99 | 1.00 | 0.60 | 0.71 | 0.81 | 0.91 | 0.53 | 0.62 | 0.72 | 0.82 | 0.35 | 0.44 | 0.53 | 0.62 | | |
| | | PI | 2.57 | 2.57 | 2.57 | 2.57 | 2.58 | 2.58 | 2.58 | 2.58 | 2.59 | 2.59 | 2.59 | 2.59 | 2.61 | 2.61 | 2.61 | 2.61 | 2.61 | |
| 950 | 18 | TC | 7.29 | 7.29 | 7.38 | 7.46 | 7.72 | 7.72 | 7.72 | 7.72 | 7.95 | 7.95 | 7.95 | 7.95 | 8.56 | 8.56 | 8.56 | 8.56 | | |
| | | S/T | 0.72 | 0.81 | 0.89 | 0.97 | 0.58 | 0.66 | 0.75 | 0.83 | 0.51 | 0.59 | 0.67 | 0.75 | 0.36 | 0.44 | 0.51 | 0.58 | | |
| | | PI | 1.55 | 1.55 | 1.55 | 1.55 | 1.54 | 1.54 | 1.54 | 1.54 | 1.54 | 1.54 | 1.54 | 1.54 | 1.53 | 1.53 | 1.53 | 1.53 | 1.53 | |
| | 25 | TC | 6.83 | 6.83 | 6.89 | 6.95 | 7.26 | 7.26 | 7.26 | 7.26 | 7.46 | 7.46 | 7.46 | 7.46 | 8.04 | 8.04 | 8.04 | 8.04 | | |
| | | S/T | 0.73 | 0.83 | 0.92 | 1.00 | 0.59 | 0.67 | 0.76 | 0.85 | 0.52 | 0.60 | 0.69 | 0.77 | 0.36 | 0.44 | 0.52 | 0.59 | | |
| | | PI | 1.79 | 1.79 | 1.79 | 1.79 | 1.78 | 1.78 | 1.78 | 1.78 | 1.78 | 1.78 | 1.78 | 1.78 | 1.79 | 1.79 | 1.79 | 1.79 | 1.79 | |
| | 30 | TC | 6.52 | 6.52 | 6.57 | 6.63 | 6.92 | 6.92 | 6.92 | 6.92 | 7.12 | 7.12 | 7.12 | 7.12 | 7.69 | 7.69 | 7.69 | 7.69 | | |
| | | S/T | 0.74 | 0.84 | 0.94 | 1.00 | 0.59 | 0.68 | 0.77 | 0.87 | 0.52 | 0.61 | 0.70 | 0.79 | 0.35 | 0.44 | 0.52 | 0.60 | | |
| | | PI | 1.95 | 1.95 | 1.95 | 1.95 | 1.95 | 1.95 | 1.95 | 1.95 | 1.96 | 1.96 | 1.96 | 1.96 | 1.96 | 1.96 | 1.96 | 1.96 | 1.96 | |
| | 35 | TC | 6.17 | 6.17 | 6.23 | 6.29 | 6.57 | 6.57 | 6.57 | 6.63 | 6.78 | 6.78 | 6.78 | 6.78 | 7.32 | 7.32 | 7.32 | 7.32 | | |
| | | S/T | 0.76 | 0.86 | 0.96 | 1.00 | 0.60 | 0.69 | 0.79 | 0.88 | 0.52 | 0.62 | 0.71 | 0.80 | 0.35 | 0.44 | 0.52 | 0.61 | | |
| | | PI | 2.13 | 2.13 | 2.13 | 2.13 | 2.14 | 2.14 | 2.14 | 2.14 | 2.15 | 2.15 | 2.15 | 2.15 | 2.15 | 2.15 | 2.15 | 2.15 | 2.15 | |
| | 40 | TC | 5.64 | 5.68 | 5.74 | 5.79 | 6.01 | 6.01 | 6.01 | 6.06 | 6.21 | 6.21 | 6.25 | 6.21 | 6.71 | 6.71 | 6.71 | 6.71 | | |
| | | S/T | 0.78 | 0.89 | 1.00 | 1.00 | 0.61 | 0.71 | 0.82 | 0.92 | 0.53 | 0.63 | 0.73 | 0.84 | 0.34 | 0.44 | 0.53 | 0.63 | | |
| | | PI | 2.44 | 2.44 | 2.44 | 2.44 | 2.45 | 2.45 | 2.45 | 2.45 | 2.46 | 2.46 | 2.46 | 2.46 | 2.47 | 2.47 | 2.47 | 2.47 | 2.47 | |
| | 43 | TC | 5.35 | 5.41 | 5.47 | 5.53 | 5.70 | 5.70 | 5.70 | 5.75 | 5.90 | 5.90 | 5.90 | 5.90 | 6.38 | 6.38 | 6.38 | 6.38 | | |
| | | S/T | 0.79 | 0.91 | 1.00 | 1.00 | 0.61 | 0.73 | 0.84 | 0.94 | 0.53 | 0.64 | 0.75 | 0.85 | 0.34 | 0.44 | 0.54 | 0.64 | | |
| | | PI | 2.62 | 2.62 | 2.62 | 2.62 | 2.63 | 2.63 | 2.63 | 2.63 | 2.64 | 2.64 | 2.64 | 2.64 | 2.66 | 2.66 | 2.66 | 2.66 | 2.66 | |
| 1160 | 18 | TC | 7.44 | 7.44 | 7.52 | 7.61 | 7.90 | 7.90 | 7.90 | 7.98 | 8.12 | 8.12 | 8.12 | 8.12 | 8.73 | 8.73 | 8.73 | 8.73 | | |
| | | S/T | 0.76 | 0.87 | 0.96 | 1.00 | 0.60 | 0.70 | 0.80 | 0.89 | 0.52 | 0.62 | 0.71 | 0.81 | 0.35 | 0.44 | 0.53 | 0.62 | | |
| | | PI | 1.58 | 1.58 | 1.58 | 1.58 | 1.57 | 1.57 | 1.57 | 1.57 | 1.57 | 1.57 | 1.57 | 1.57 | 1.55 | 1.55 | 1.55 | 1.55 | 1.55 | |
| | 25 | TC | 6.98 | 7.03 | 7.09 | 7.15 | 7.41 | 7.41 | 7.41 | 7.49 | 7.64 | 7.64 | 7.64 | 7.64 | 8.21 | 8.21 | 8.21 | 8.21 | | |
| | | S/T | 0.78 | 0.89 | 0.99 | 1.00 | 0.61 | 0.71 | 0.82 | 0.92 | 0.53 | 0.63 | 0.73 | 0.83 | 0.34 | 0.44 | 0.53 | 0.63 | | |
| | | PI | 1.82 | 1.82 | 1.82 | 1.82 | 1.82 | 1.82 | 1.82 | 1.82 | 1.82 | 1.82 | 1.82 | 1.82 | 1.82 | 1.82 | 1.82 | 1.82 | 1.82 | 1.82 |
| | 30 | TC | 6.63 | 6.69 | 6.75 | 6.80 | 7.06 | 7.06 | 7.06 | 7.12 | 7.29 | 7.29 | 7.29 | 7.29 | 7.84 | 7.84 | 7.84 | 7.84 | | |
| | | S/T | 0.79 | 0.91 | 1.00 | 1.00 | 0.61 | 0.72 | 0.83 | 0.94 | 0.53 | 0.64 | 0.74 | 0.85 | 0.34 | 0.44 | 0.54 | 0.64 | | |
| | | PI | 1.98 | 1.98 | 1.98 | 1.98 | 1.99 | 1.99 | 1.99 | 1.99 | 1.99 | 1.99 | 1.99 | 1.99 | 2.00 | 2.00 | 2.00 | 2.00 | 2.00 | |
| | 35 | TC | 6.32 | 6.37 | 6.43 | 6.49 | 6.72 | 6.72 | 6.72 | 6.78 | 6.92 | 6.92 | 6.92 | 6.92 | 7.46 | 7.46 | 7.46 | 7.46 | | |
| | | S/T | 0.81 | 0.93 | 1.00 | 1.00 | 0.62 | 0.74 | 0.85 | 0.96 | 0.54 | 0.65 | 0.76 | 0.87 | 0.34 | 0.44 | 0.55 | 0.65 | | |
| | | PI | 2.17 | 2.17 | 2.17 | 2.17 | 2.18 | 2.18 | 2.18 | 2.18 | 2.19 | 2.19 | 2.19 | 2.19 | 2.20 | 2.20 | 2.20 | 2.20 | 2.20 | |
| | 40 | TC | 5.77 | 5.82 | 5.88 | 5.94 | 6.15 | 6.15 | 6.18 | 6.24 | 6.33 | 6.33 | 6.37 | 6.37 | 6.85 | 6.85 | 6.85 | 6.85 | | |
| | | S/T | 0.84 | 0.97 | 1.00 | 1.00 | 0.64 | 0.77 | 0.89 | 1.00 | 0.55 | 0.67 | 0.79 | 0.91 | 0.33 | 0.45 | 0.56 | 0.90 | | |
| | | PI | 2.48 | 2.48 | 2.48 | 2.48 | 2.49 | 2.49 | 2.49 | 2.49 | 2.50 | 2.50 | 2.50 | 2.50 | 2.52 | 2.52 | 2.52 | 2.52 | 2.52 | |
| | 43 | TC | 5.47 | 5.53 | 5.58 | 5.64 | 5.84 | 5.84 | 5.90 | 5.95 | 6.01 | 6.01 | 6.01 | 6.07 | 6.52 | 6.52 | 6.52 | 6.52 | | |
| | | S/T | 0.85 | 0.99 | 1.00 | 1.00 | 0.65 | 0.78 | 0.91 | 1.00 | 0.55 | 0.68 | 0.81 | 0.93 | 0.33 | 0.45 | 0.57 | 0.92 | | |
| | | PI | 2.67 | 2.67 | 2.67 | 2.67 | 2.68 | 2.68 | 2.68 | 2.68 | 2.69 | 2.69 | 2.69 | 2.69 | 2.71 | 2.71 | 2.71 | 2.71 | 2.71 | |

TC:Total Cooling Capacity (kW)

S/T:Sensible Cooling Capacity Ratio

PI:Power Input(kW)

8.2 Heating

| KSGA21HFRN1 / KSRA21HFRN1 | | | | | | | | [SI_Unit] | |
|---------------------------|--|--------------------------------|------|------|------|------------------------------|------|-----------|------|
| INDOOR AIRFLOW (CMH) | HEATING PERFORMANCE AT INDOOR DRY BULB TEMPERATURE | | | | | | | | |
| | OUTDOOR DB(C) | TC:TOTAL CAPACITY IN KILOWATTS | | | | PI: TOTAL POWER IN KILOWATTS | | | |
| | | Indoor Conditions (DB °C) | | | | Indoor Conditions (DB °C) | | | |
| | | 16.0 | 20.0 | 22.0 | 24.0 | 16.0 | 20.0 | 22.0 | 24.0 |
| 320 | -7.0 | 1.55 | 1.52 | 1.52 | 1.49 | 0.43 | 0.44 | 0.46 | 0.47 |
| | -5.6 | 1.64 | 1.61 | 1.61 | 1.58 | 0.44 | 0.46 | 0.47 | 0.49 |
| | -2.8 | 1.69 | 1.69 | 1.66 | 1.66 | 0.47 | 0.49 | 0.51 | 0.52 |
| | 0.0 | 1.78 | 1.75 | 1.72 | 1.72 | 0.50 | 0.52 | 0.54 | 0.55 |
| | 2.8 | 1.90 | 1.87 | 1.87 | 1.84 | 0.53 | 0.56 | 0.57 | 0.59 |
| | 5.6 | 2.10 | 2.07 | 2.04 | 2.04 | 0.57 | 0.60 | 0.61 | 0.62 |
| | 7.0 | 2.29 | 2.26 | 2.20 | 2.17 | 0.58 | 0.63 | 0.62 | 0.63 |
| | 11.1 | 2.43 | 2.40 | 2.37 | 2.37 | 0.62 | 0.65 | 0.67 | 0.69 |
| | 13.9 | 2.55 | 2.52 | 2.49 | 2.49 | 0.66 | 0.69 | 0.70 | 0.72 |
| | 16.7 | 2.69 | 2.63 | 2.63 | 2.61 | 0.69 | 0.72 | 0.74 | 0.75 |
| 18.0 | 2.75 | 2.69 | 2.69 | 2.66 | 0.70 | 0.74 | 0.75 | 0.77 | |
| 390 | -7.0 | 1.57 | 1.54 | 1.54 | 1.51 | 0.44 | 0.45 | 0.47 | 0.48 |
| | -5.6 | 1.66 | 1.64 | 1.64 | 1.61 | 0.45 | 0.47 | 0.48 | 0.49 |
| | -2.8 | 1.75 | 1.72 | 1.69 | 1.69 | 0.48 | 0.50 | 0.51 | 0.53 |
| | 0.0 | 1.81 | 1.78 | 1.78 | 1.75 | 0.51 | 0.53 | 0.55 | 0.56 |
| | 2.8 | 1.93 | 1.93 | 1.90 | 1.90 | 0.54 | 0.57 | 0.58 | 0.60 |
| | 5.6 | 2.16 | 2.13 | 2.10 | 2.10 | 0.58 | 0.61 | 0.62 | 0.63 |
| | 7.0 | 2.35 | 2.32 | 2.26 | 2.23 | 0.59 | 0.64 | 0.63 | 0.64 |
| | 11.1 | 2.49 | 2.46 | 2.43 | 2.43 | 0.63 | 0.67 | 0.68 | 0.70 |
| | 13.9 | 2.63 | 2.58 | 2.58 | 2.55 | 0.67 | 0.70 | 0.71 | 0.73 |
| | 16.7 | 2.75 | 2.72 | 2.69 | 2.69 | 0.70 | 0.73 | 0.75 | 0.77 |
| 18.0 | 2.81 | 2.78 | 2.75 | 2.75 | 0.71 | 0.75 | 0.76 | 0.78 | |
| 470 | -7.0 | 1.58 | 1.55 | 1.55 | 1.55 | 0.44 | 0.45 | 0.47 | 0.48 |
| | -5.6 | 1.66 | 1.64 | 1.64 | 1.64 | 0.45 | 0.48 | 0.49 | 0.50 |
| | -2.8 | 1.75 | 1.72 | 1.72 | 1.72 | 0.48 | 0.51 | 0.52 | 0.53 |
| | 0.0 | 1.81 | 1.81 | 1.78 | 1.78 | 0.51 | 0.54 | 0.55 | 0.56 |
| | 2.8 | 1.96 | 1.93 | 1.93 | 1.90 | 0.55 | 0.58 | 0.59 | 0.60 |
| | 5.6 | 2.16 | 2.13 | 2.13 | 2.10 | 0.59 | 0.61 | 0.63 | 0.64 |
| | 7.0 | 2.38 | 2.34 | 2.29 | 2.26 | 0.60 | 0.65 | 0.64 | 0.65 |
| | 11.1 | 2.52 | 2.49 | 2.46 | 2.46 | 0.64 | 0.68 | 0.69 | 0.71 |
| | 13.9 | 2.66 | 2.63 | 2.61 | 2.58 | 0.68 | 0.71 | 0.73 | 0.74 |
| | 16.7 | 2.81 | 2.75 | 2.75 | 2.72 | 0.71 | 0.75 | 0.76 | 0.78 |
| 18.0 | 2.87 | 2.84 | 2.81 | 2.78 | 0.73 | 0.76 | 0.78 | 0.80 | |

| KSGA26HFRN1 / KSRA26HFRN1 | | | | | | | | [SI_Unit] | |
|---------------------------|--|---------------------------------|------|------|------|------------------------------|------|-----------|------|
| INDOOR AIRFLOW (CMH) | HEATING PERFORMANCE AT INDOOR DRY BULB TEMPERATURE | | | | | | | | |
| | OUTDOOR DB(C) | TC: TOTAL CAPACITY IN KILOWATTS | | | | PI: TOTAL POWER IN KILOWATTS | | | |
| | | Indoor Conditions (DB °C) | | | | Indoor Conditions (DB °C) | | | |
| | | 16.0 | 20.0 | 22.0 | 24.0 | 16.0 | 20.0 | 22.0 | 24.0 |
| 330 | -7.0 | 1.81 | 1.78 | 1.75 | 1.75 | 0.51 | 0.52 | 0.54 | 0.56 |
| | -5.6 | 1.93 | 1.90 | 1.87 | 1.87 | 0.52 | 0.55 | 0.56 | 0.57 |
| | -2.8 | 2.01 | 1.98 | 1.98 | 1.95 | 0.55 | 0.58 | 0.60 | 0.61 |
| | 0.0 | 2.10 | 2.07 | 2.04 | 2.04 | 0.59 | 0.62 | 0.63 | 0.64 |
| | 2.8 | 2.25 | 2.22 | 2.22 | 2.19 | 0.63 | 0.66 | 0.67 | 0.69 |
| | 5.6 | 2.48 | 2.45 | 2.45 | 2.42 | 0.67 | 0.70 | 0.72 | 0.73 |
| | 7.0 | 2.73 | 2.70 | 2.61 | 2.61 | 0.69 | 0.75 | 0.74 | 0.76 |
| | 11.1 | 2.90 | 2.87 | 2.84 | 2.81 | 0.74 | 0.78 | 0.80 | 0.81 |
| | 13.9 | 3.05 | 3.02 | 2.99 | 2.99 | 0.78 | 0.82 | 0.83 | 0.85 |
| | 16.7 | 3.22 | 3.16 | 3.16 | 3.13 | 0.82 | 0.85 | 0.87 | 0.89 |
| | 18.0 | 3.31 | 3.25 | 3.22 | 3.19 | 0.83 | 0.87 | 0.89 | 0.91 |
| 460 | -7.0 | 1.86 | 1.83 | 1.83 | 1.83 | 0.51 | 0.52 | 0.55 | 0.56 |
| | -5.6 | 1.95 | 1.93 | 1.93 | 1.93 | 0.52 | 0.55 | 0.56 | 0.58 |
| | -2.8 | 2.07 | 2.04 | 2.01 | 2.01 | 0.56 | 0.59 | 0.60 | 0.61 |
| | 0.0 | 2.13 | 2.10 | 2.10 | 2.07 | 0.59 | 0.62 | 0.64 | 0.65 |
| | 2.8 | 2.30 | 2.28 | 2.25 | 2.25 | 0.63 | 0.66 | 0.68 | 0.70 |
| | 5.6 | 2.54 | 2.51 | 2.51 | 2.48 | 0.68 | 0.71 | 0.72 | 0.74 |
| | 7.0 | 2.79 | 2.76 | 2.67 | 2.67 | 0.70 | 0.76 | 0.75 | 0.77 |
| | 11.1 | 2.96 | 2.93 | 2.90 | 2.87 | 0.75 | 0.79 | 0.81 | 0.83 |
| | 13.9 | 3.13 | 3.07 | 3.05 | 3.05 | 0.79 | 0.83 | 0.85 | 0.87 |
| | 16.7 | 3.28 | 3.25 | 3.22 | 3.19 | 0.83 | 0.87 | 0.89 | 0.91 |
| | 18.0 | 3.36 | 3.31 | 3.28 | 3.28 | 0.85 | 0.89 | 0.91 | 0.93 |
| 530 | -7.0 | 1.87 | 1.84 | 1.81 | 1.81 | 0.52 | 0.53 | 0.55 | 0.57 |
| | -5.6 | 1.98 | 1.95 | 1.93 | 1.93 | 0.53 | 0.56 | 0.57 | 0.59 |
| | -2.8 | 2.07 | 2.04 | 2.04 | 2.01 | 0.57 | 0.59 | 0.61 | 0.62 |
| | 0.0 | 2.16 | 2.13 | 2.13 | 2.10 | 0.60 | 0.63 | 0.64 | 0.66 |
| | 2.8 | 2.33 | 2.30 | 2.28 | 2.25 | 0.64 | 0.67 | 0.69 | 0.70 |
| | 5.6 | 2.57 | 2.54 | 2.51 | 2.51 | 0.68 | 0.72 | 0.73 | 0.75 |
| | 7.0 | 2.82 | 2.78 | 2.70 | 2.67 | 0.71 | 0.77 | 0.76 | 0.78 |
| | 11.1 | 2.99 | 2.96 | 2.93 | 2.93 | 0.76 | 0.80 | 0.82 | 0.84 |
| | 13.9 | 3.16 | 3.10 | 3.10 | 3.07 | 0.80 | 0.84 | 0.86 | 0.88 |
| | 16.7 | 3.31 | 3.28 | 3.25 | 3.22 | 0.84 | 0.88 | 0.90 | 0.92 |
| | 18.0 | 3.39 | 3.36 | 3.34 | 3.31 | 0.86 | 0.90 | 0.92 | 0.94 |

| KSGA35HFRN1 / KSRA35HFRN1 | | | | | | | | [SI_Unit] | |
|---------------------------|--|---------------------------------|------|------|------|------------------------------|------|-----------|------|
| INDOOR AIRFLOW (CMH) | HEATING PERFORMANCE AT INDOOR DRY BULB TEMPERATURE | | | | | | | | |
| | OUTDOOR DB(°C) | TC: TOTAL CAPACITY IN KILOWATTS | | | | PI: TOTAL POWER IN KILOWATTS | | | |
| | | Indoor Conditions (DB °C) | | | | Indoor Conditions (DB °C) | | | |
| | | 16.0 | 20.0 | 22.0 | 24.0 | 16.0 | 20.0 | 22.0 | 24.0 |
| 360 | -7.0 | 1.95 | 1.93 | 1.93 | 1.90 | 0.77 | 0.79 | 0.81 | 0.83 |
| | -5.6 | 2.16 | 2.13 | 2.13 | 2.10 | 0.78 | 0.81 | 0.83 | 0.84 |
| | -2.8 | 2.40 | 2.34 | 2.34 | 2.31 | 0.81 | 0.84 | 0.85 | 0.87 |
| | 0.0 | 2.57 | 2.51 | 2.51 | 2.48 | 0.83 | 0.87 | 0.88 | 0.90 |
| | 2.8 | 2.83 | 2.81 | 2.78 | 2.75 | 0.87 | 0.90 | 0.92 | 0.94 |
| | 5.6 | 3.24 | 3.19 | 3.16 | 3.13 | 0.91 | 0.94 | 0.96 | 0.98 |
| | 7.0 | 3.64 | 3.58 | 3.43 | 3.40 | 0.93 | 0.99 | 0.98 | 1.00 |
| | 11.1 | 3.93 | 3.87 | 3.84 | 3.81 | 0.97 | 1.01 | 1.03 | 1.05 |
| | 13.9 | 4.19 | 4.16 | 4.13 | 4.10 | 1.00 | 1.05 | 1.07 | 1.09 |
| | 16.7 | 4.48 | 4.42 | 4.39 | 4.36 | 1.04 | 1.08 | 1.10 | 1.12 |
| 18.0 | 4.62 | 4.56 | 4.54 | 4.51 | 1.05 | 1.09 | 1.12 | 1.14 | |
| 480 | -7.0 | 2.01 | 1.98 | 1.98 | 1.95 | 0.78 | 0.80 | 0.82 | 0.84 |
| | -5.6 | 2.22 | 2.19 | 2.19 | 2.16 | 0.79 | 0.82 | 0.84 | 0.85 |
| | -2.8 | 2.43 | 2.40 | 2.40 | 2.37 | 0.82 | 0.85 | 0.87 | 0.88 |
| | 0.0 | 2.60 | 2.57 | 2.54 | 2.54 | 0.84 | 0.88 | 0.89 | 0.91 |
| | 2.8 | 2.89 | 2.86 | 2.83 | 2.81 | 0.88 | 0.92 | 0.93 | 0.95 |
| | 5.6 | 3.27 | 3.24 | 3.21 | 3.19 | 0.92 | 0.96 | 0.97 | 0.99 |
| | 7.0 | 3.67 | 3.63 | 3.49 | 3.46 | 0.94 | 1.01 | 1.00 | 1.02 |
| | 11.1 | 3.98 | 3.93 | 3.90 | 3.87 | 0.99 | 1.03 | 1.05 | 1.07 |
| | 13.9 | 4.25 | 4.22 | 4.19 | 4.16 | 1.02 | 1.06 | 1.08 | 1.10 |
| | 16.7 | 4.54 | 4.48 | 4.45 | 4.42 | 1.05 | 1.10 | 1.12 | 1.14 |
| 18.0 | 4.68 | 4.62 | 4.59 | 4.56 | 1.07 | 1.11 | 1.13 | 1.16 | |
| 560 | -7.0 | 2.04 | 1.99 | 1.99 | 1.96 | 0.79 | 0.81 | 0.83 | 0.85 |
| | -5.6 | 2.25 | 2.19 | 2.19 | 2.16 | 0.80 | 0.83 | 0.85 | 0.86 |
| | -2.8 | 2.45 | 2.43 | 2.40 | 2.37 | 0.83 | 0.86 | 0.88 | 0.89 |
| | 0.0 | 2.63 | 2.60 | 2.57 | 2.54 | 0.86 | 0.89 | 0.91 | 0.92 |
| | 2.8 | 2.92 | 2.86 | 2.86 | 2.83 | 0.89 | 0.93 | 0.95 | 0.97 |
| | 5.6 | 3.30 | 3.27 | 3.24 | 3.21 | 0.93 | 0.97 | 0.99 | 1.01 |
| | 7.0 | 3.70 | 3.66 | 3.52 | 3.49 | 0.95 | 1.02 | 1.01 | 1.03 |
| | 11.1 | 4.01 | 3.95 | 3.93 | 3.90 | 1.00 | 1.04 | 1.06 | 1.08 |
| | 13.9 | 4.30 | 4.25 | 4.22 | 4.19 | 1.04 | 1.08 | 1.10 | 1.12 |
| | 16.7 | 4.59 | 4.54 | 4.51 | 4.48 | 1.07 | 1.11 | 1.13 | 1.16 |
| 18.0 | 4.71 | 4.65 | 4.62 | 4.59 | 1.09 | 1.13 | 1.15 | 1.17 | |

| KSGA53HFRN1 / KSRA53HFRN1 | | | | | | | | [SI_Unit] | |
|---------------------------|--|---------------------------------|------|------|------|------------------------------|------|-----------|------|
| INDOOR AIRFLOW (CMH) | HEATING PERFORMANCE AT INDOOR DRY BULB TEMPERATURE | | | | | | | | |
| | OUTDOOR DB(°C) | TC: TOTAL CAPACITY IN KILOWATTS | | | | PI: TOTAL POWER IN KILOWATTS | | | |
| | | Indoor Conditions (DB °C) | | | | Indoor Conditions (DB °C) | | | |
| | | 16.0 | 20.0 | 22.0 | 24.0 | 16.0 | 20.0 | 22.0 | 24.0 |
| 543 | -7.0 | 2.72 | 2.67 | 2.67 | 2.64 | 1.18 | 1.21 | 1.24 | 1.27 |
| | -5.6 | 3.08 | 3.02 | 3.02 | 2.99 | 1.19 | 1.24 | 1.26 | 1.29 |
| | -2.8 | 3.42 | 3.37 | 3.34 | 3.34 | 1.24 | 1.28 | 1.31 | 1.33 |
| | 0.0 | 3.71 | 3.68 | 3.66 | 3.63 | 1.28 | 1.33 | 1.35 | 1.38 |
| | 2.8 | 4.18 | 4.12 | 4.09 | 4.06 | 1.33 | 1.39 | 1.41 | 1.44 |
| | 5.6 | 4.82 | 4.76 | 4.70 | 4.67 | 1.39 | 1.45 | 1.47 | 1.50 |
| | 7.0 | 5.46 | 5.39 | 5.16 | 5.13 | 1.42 | 1.51 | 1.50 | 1.53 |
| | 11.1 | 5.95 | 5.86 | 5.83 | 5.80 | 1.49 | 1.55 | 1.57 | 1.60 |
| | 13.9 | 6.41 | 6.32 | 6.29 | 6.24 | 1.53 | 1.60 | 1.63 | 1.66 |
| | 16.7 | 6.87 | 6.79 | 6.73 | 6.70 | 1.58 | 1.65 | 1.68 | 1.71 |
| 18.0 | 7.08 | 6.99 | 6.96 | 6.90 | 1.61 | 1.67 | 1.70 | 1.74 | |
| 619 | -7.0 | 2.75 | 2.73 | 2.70 | 2.68 | 1.19 | 1.22 | 1.26 | 1.28 |
| | -5.6 | 3.13 | 3.10 | 3.08 | 3.05 | 1.21 | 1.25 | 1.28 | 1.30 |
| | -2.8 | 3.51 | 3.45 | 3.42 | 3.39 | 1.25 | 1.30 | 1.32 | 1.34 |
| | 0.0 | 3.80 | 3.74 | 3.71 | 3.68 | 1.29 | 1.34 | 1.36 | 1.39 |
| | 2.8 | 4.26 | 4.21 | 4.18 | 4.15 | 1.34 | 1.40 | 1.42 | 1.45 |
| | 5.6 | 4.90 | 4.84 | 4.82 | 4.79 | 1.40 | 1.46 | 1.48 | 1.51 |
| | 7.0 | 5.58 | 5.51 | 5.28 | 5.25 | 1.43 | 1.53 | 1.51 | 1.54 |
| | 11.1 | 6.06 | 6.00 | 5.95 | 5.92 | 1.50 | 1.56 | 1.59 | 1.62 |
| | 13.9 | 6.55 | 6.47 | 6.41 | 6.38 | 1.55 | 1.61 | 1.64 | 1.67 |
| | 16.7 | 7.02 | 6.93 | 6.87 | 6.84 | 1.59 | 1.66 | 1.69 | 1.72 |
| 18.0 | 7.25 | 7.16 | 7.11 | 7.05 | 1.62 | 1.68 | 1.72 | 1.75 | |
| 822 | -7.0 | 2.78 | 2.76 | 2.73 | 2.70 | 1.20 | 1.23 | 1.27 | 1.29 |
| | -5.6 | 3.16 | 3.13 | 3.10 | 3.08 | 1.22 | 1.26 | 1.29 | 1.31 |
| | -2.8 | 3.54 | 3.48 | 3.45 | 3.42 | 1.26 | 1.31 | 1.33 | 1.36 |
| | 0.0 | 3.86 | 3.80 | 3.77 | 3.74 | 1.30 | 1.35 | 1.38 | 1.40 |
| | 2.8 | 4.32 | 4.26 | 4.24 | 4.21 | 1.36 | 1.41 | 1.44 | 1.47 |
| | 5.6 | 4.96 | 4.90 | 4.87 | 4.82 | 1.42 | 1.47 | 1.50 | 1.53 |
| | 7.0 | 5.63 | 5.57 | 5.34 | 5.28 | 1.44 | 1.54 | 1.53 | 1.56 |
| | 11.1 | 6.15 | 6.06 | 6.03 | 5.97 | 1.51 | 1.58 | 1.61 | 1.64 |
| | 13.9 | 6.61 | 6.53 | 6.50 | 6.44 | 1.57 | 1.63 | 1.66 | 1.69 |
| | 16.7 | 7.08 | 6.99 | 6.96 | 6.90 | 1.62 | 1.68 | 1.71 | 1.75 |
| 18.0 | 7.31 | 7.22 | 7.19 | 7.13 | 1.64 | 1.71 | 1.74 | 1.77 | |

| KSGA70HFRN1 / KSRA70HFRN1 | | | | | | | | [SI_Unit] | |
|---------------------------|--|---------------------------------|------|------|------|------------------------------|------|-----------|------|
| INDOOR AIRFLOW (CMH) | HEATING PERFORMANCE AT INDOOR DRY BULB TEMPERATURE | | | | | | | | |
| | OUTDOOR DB(°C) | TC: TOTAL CAPACITY IN KILOWATTS | | | | PI: TOTAL POWER IN KILOWATTS | | | |
| | | Indoor Conditions (DB °C) | | | | Indoor Conditions (DB °C) | | | |
| | | 16.0 | 20.0 | 22.0 | 24.0 | 16.0 | 20.0 | 22.0 | 24.0 |
| 860 | -7.0 | 3.40 | 3.34 | 3.32 | 3.29 | 1.38 | 1.42 | 1.48 | 1.51 |
| | -5.6 | 3.90 | 3.84 | 3.81 | 3.78 | 1.42 | 1.49 | 1.52 | 1.55 |
| | -2.8 | 4.42 | 4.33 | 4.30 | 4.28 | 1.50 | 1.57 | 1.61 | 1.64 |
| | 0.0 | 4.83 | 4.77 | 4.71 | 4.68 | 1.58 | 1.65 | 1.69 | 1.73 |
| | 2.8 | 5.47 | 5.38 | 5.35 | 5.29 | 1.68 | 1.76 | 1.80 | 1.84 |
| | 5.6 | 6.31 | 6.22 | 6.20 | 6.14 | 1.78 | 1.86 | 1.90 | 1.94 |
| | 7.0 | 7.19 | 7.10 | 6.78 | 6.72 | 1.84 | 1.99 | 1.96 | 2.01 |
| | 11.1 | 7.85 | 7.76 | 7.70 | 7.65 | 1.97 | 2.06 | 2.10 | 2.14 |
| | 13.9 | 8.49 | 8.37 | 8.34 | 8.28 | 2.06 | 2.14 | 2.19 | 2.24 |
| | 16.7 | 9.12 | 9.01 | 8.95 | 8.89 | 2.14 | 2.24 | 2.29 | 2.34 |
| 18.0 | 9.44 | 9.33 | 9.27 | 9.18 | 2.18 | 2.28 | 2.33 | 2.38 | |
| 950 | -7.0 | 3.46 | 3.41 | 3.38 | 3.36 | 1.40 | 1.43 | 1.49 | 1.52 |
| | -5.6 | 3.98 | 3.93 | 3.90 | 3.87 | 1.43 | 1.50 | 1.53 | 1.57 |
| | -2.8 | 4.48 | 4.42 | 4.39 | 4.36 | 1.51 | 1.58 | 1.62 | 1.66 |
| | 0.0 | 4.92 | 4.86 | 4.80 | 4.77 | 1.59 | 1.67 | 1.71 | 1.74 |
| | 2.8 | 5.58 | 5.50 | 5.47 | 5.41 | 1.70 | 1.77 | 1.81 | 1.85 |
| | 5.6 | 6.46 | 6.37 | 6.31 | 6.28 | 1.80 | 1.88 | 1.92 | 1.96 |
| | 7.0 | 7.34 | 7.24 | 6.92 | 6.86 | 1.85 | 2.01 | 1.98 | 2.03 |
| | 11.1 | 8.02 | 7.91 | 7.85 | 7.82 | 1.99 | 2.08 | 2.12 | 2.16 |
| | 13.9 | 8.66 | 8.54 | 8.49 | 8.46 | 2.08 | 2.17 | 2.21 | 2.26 |
| | 16.7 | 9.33 | 9.21 | 9.15 | 9.09 | 2.16 | 2.26 | 2.31 | 2.36 |
| 18.0 | 9.61 | 9.50 | 9.44 | 9.38 | 2.20 | 2.31 | 2.36 | 2.41 | |
| 1160 | -7.0 | 3.48 | 3.43 | 3.41 | 3.38 | 1.41 | 1.45 | 1.51 | 1.54 |
| | -5.6 | 4.01 | 3.96 | 3.93 | 3.90 | 1.45 | 1.52 | 1.55 | 1.59 |
| | -2.8 | 4.54 | 4.48 | 4.42 | 4.39 | 1.53 | 1.60 | 1.64 | 1.67 |
| | 0.0 | 4.97 | 4.92 | 4.86 | 4.83 | 1.61 | 1.69 | 1.73 | 1.76 |
| | 2.8 | 5.64 | 5.56 | 5.53 | 5.47 | 1.71 | 1.79 | 1.83 | 1.87 |
| | 5.6 | 6.51 | 6.43 | 6.40 | 6.34 | 1.82 | 1.90 | 1.94 | 1.98 |
| | 7.0 | 7.43 | 7.33 | 6.98 | 6.95 | 1.87 | 2.03 | 2.00 | 2.05 |
| | 11.1 | 8.11 | 7.99 | 7.96 | 7.91 | 2.01 | 2.09 | 2.14 | 2.18 |
| | 13.9 | 8.78 | 8.66 | 8.60 | 8.54 | 2.09 | 2.19 | 2.23 | 2.28 |
| | 16.7 | 9.44 | 9.33 | 9.27 | 9.21 | 2.18 | 2.28 | 2.33 | 2.38 |
| 18.0 | 9.76 | 9.61 | 9.56 | 9.50 | 2.22 | 2.33 | 2.38 | 2.43 | |

9. Noise Criterion Curves

9.1 Indoor Unit

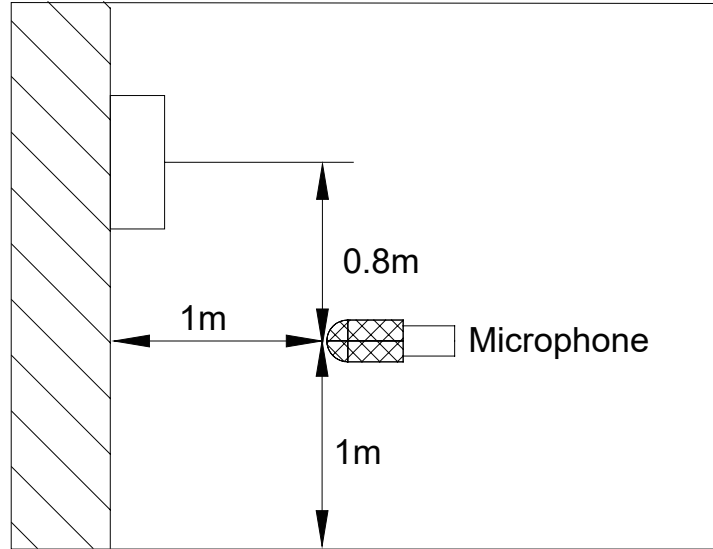

Notes:

- Sound measured at 1.0m away from the center of the unit.
- Data is valid at free field condition
- Data is valid at nominal operation condition
- Reference acoustic pressure $OdB = 20\mu Pa$
- Sound level will vary depending on a range of factors such as the construction -(acoustic absorption coefficient) of particular room in which the equipment is installed.
- The operating conditions are assumed to be standard.

KSGA21HFRN1

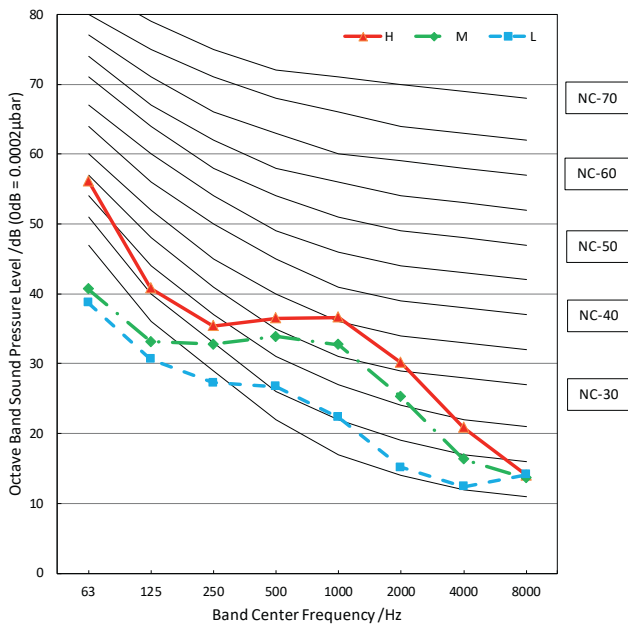

KSGA26HFRN1

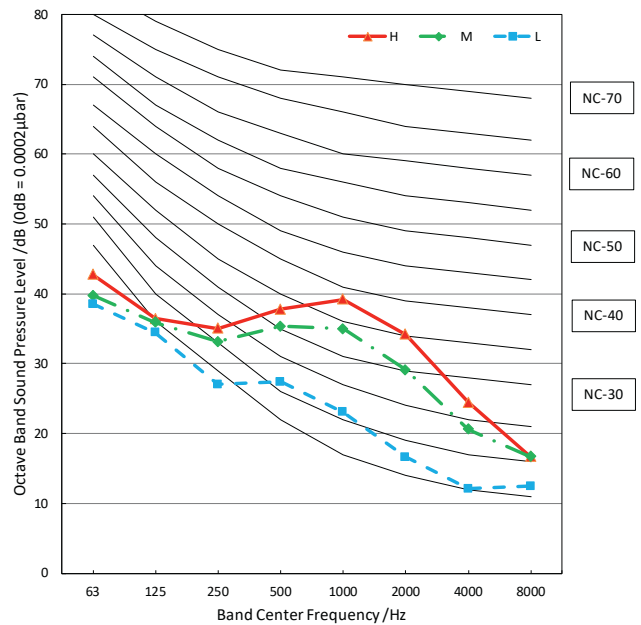

KSGA35HFRN1

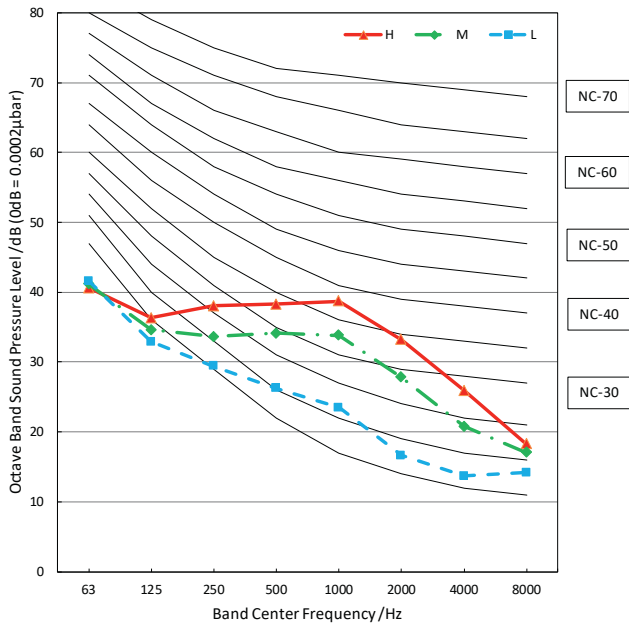

KSGA53HFRN1

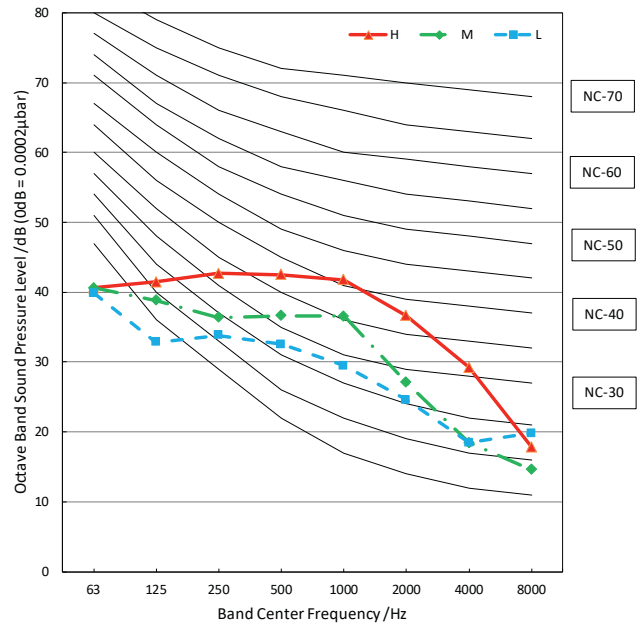

KSGA70HFRN1

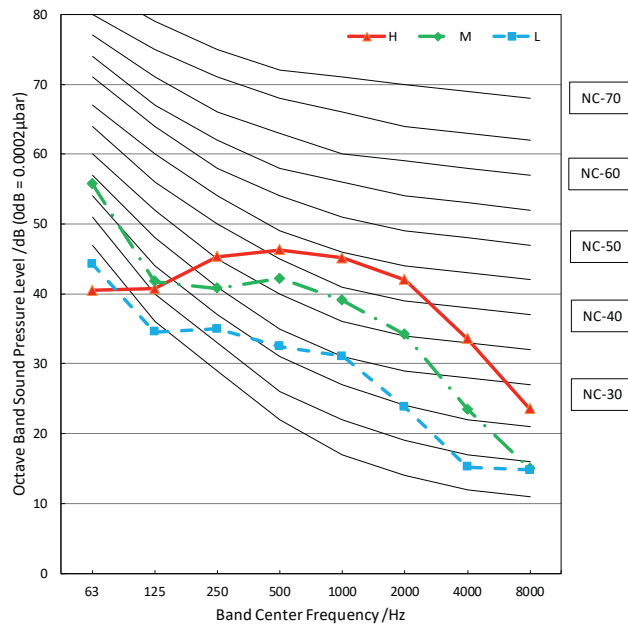

9.2 Outdoor Unit

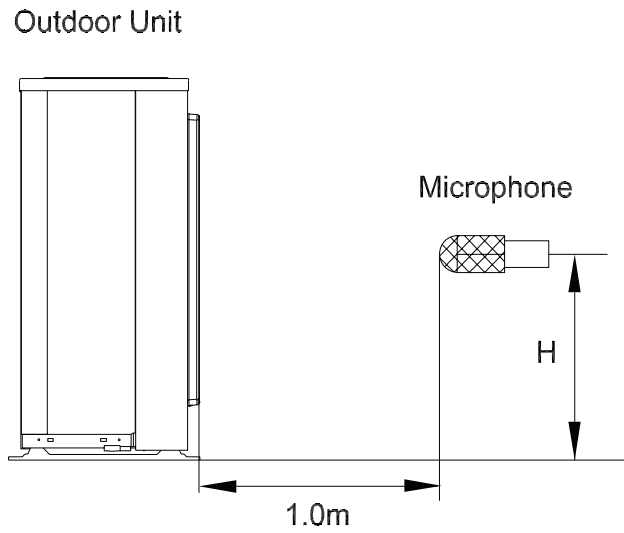

Note: $H = 0.5 \times \text{height of outdoor unit}$

Notes:

- Sound measured at 1.0m away from the center of the unit.
- Data is valid at free field condition
- Data is valid at nominal operation condition
- Reference acoustic pressure $OdB=20\mu Pa$
- Sound level will vary depending on arrange off actors such as the construction (acoustic absorption coefficient) of particular room in which the equipment is installed.
- The operating conditions are assumed to be standard.

KSRA21HFRN1

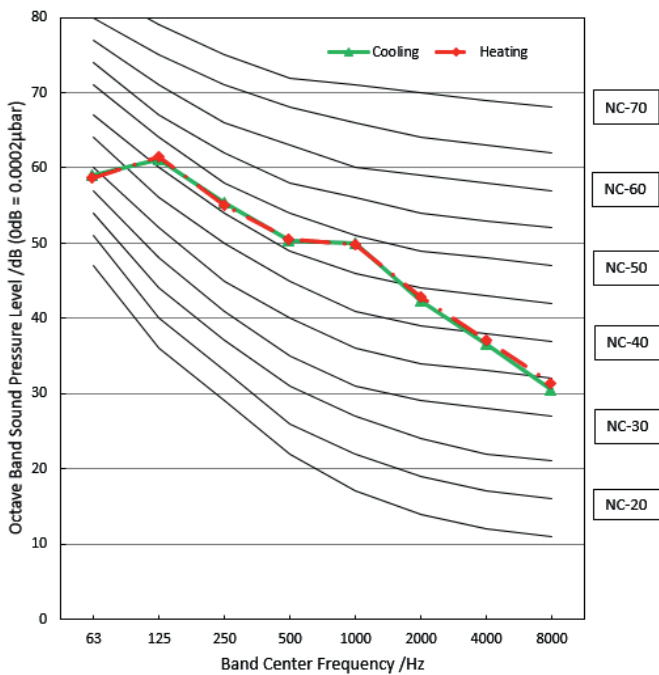

KSRA26HFRN1

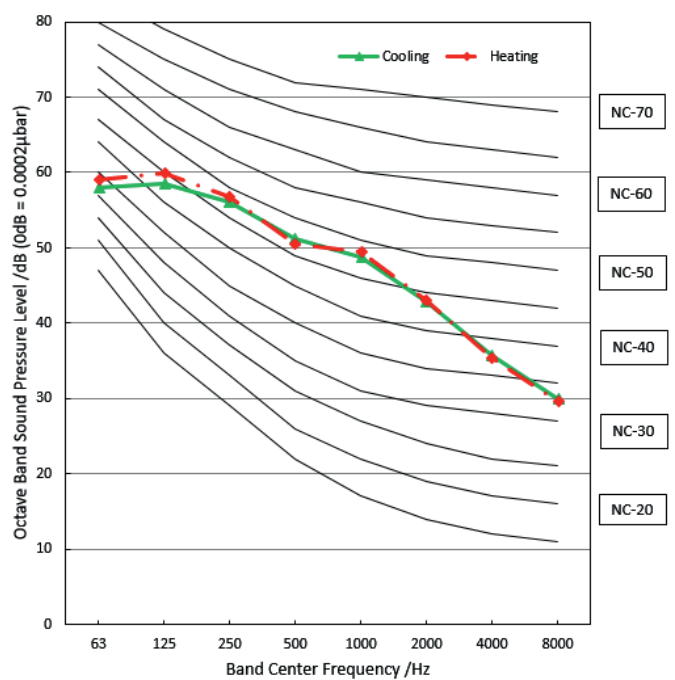

KSRA35HFRN1

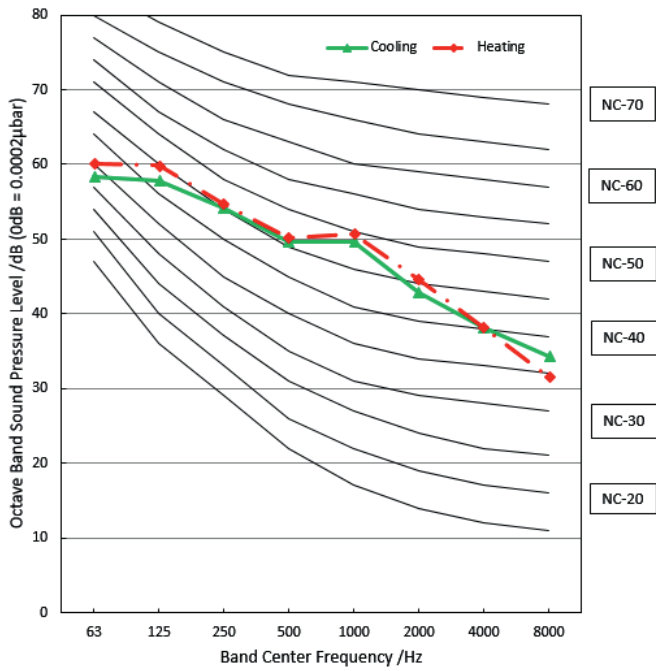

KSRA53HFRN1

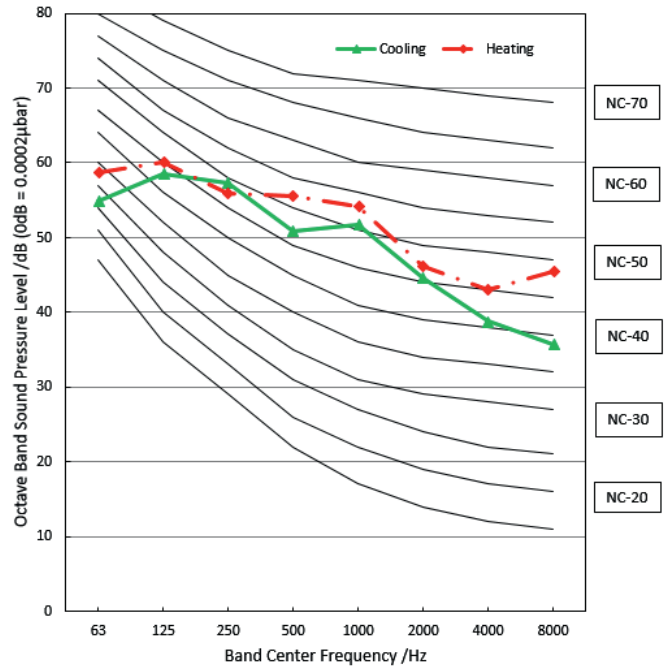

KSRA70HFRN1

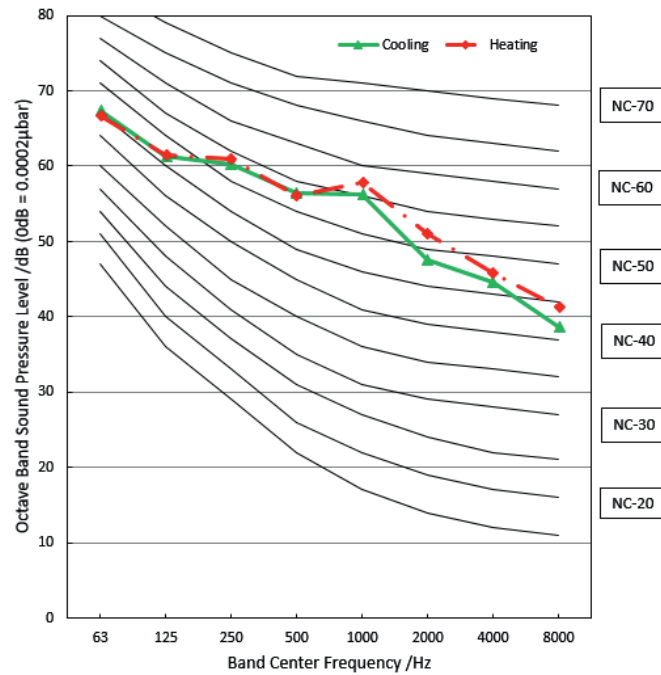

10. Electrical Characteristics

| Model | Outdoor Unit | | | Power Supply | | | IFM | | Compressor | | OFM | | |
|-------------|--------------|----|---------|--------------|-------|-----|------|-------|------------|------|-----|-----|-------|
| | Phase | Hz | Voltage | MCA | MOP | MFA | W | FLA | MSC | RLA | Qty | W | FLA |
| KSGA21HFRN1 | 1 | 50 | 220-240 | 4.25 | 7.30 | 15 | 20 | 0.203 | 18 | 3.05 | 1 | 21 | 0.239 |
| KSGA26HFRN1 | | | | 4.31 | 7.36 | 15 | 20 | 0.203 | 18 | 3.05 | 1 | 24 | 0.290 |
| KSGA35HFRN1 | | | Min:198 | 5.74 | 9.94 | 15 | 20 | 0.203 | 25 | 4.20 | 1 | 24 | 0.290 |
| KSGA53HFRN1 | | | Max:264 | 8.56 | 14.96 | 20 | 28 | 0.24 | 38 | 6.40 | 1 | 24 | 0.315 |
| KSGA70HFRN1 | | | 10.08 | 17.38 | 25 | 45 | 0.35 | 42 | 7.30 | 1 | 65 | 0.6 | |

Notes:

MCA: Minimum Circuit Amperes (A)

MOP: Maximum rating over current protective device

MFA: Maximum Fuse Amperes (A)

MSC: Maximum Starting Current

RLA: Rated Load Amperes (A)

IFM: Indoor Fan Motor

OFM: Outdoor Fan Motor

FLA: Full Load Amperes (A)

W: Fan Motor Rated Output(W)

Product Features

| Contents | Page |
|---|-----------|
| 1. Operation Modes and Functions..... | 48 |
| 1.1 Abbreviation..... | 48 |
| 1.2 Safety Features | 48 |
| 1.3 Digital Display | 48 |
| 1.4 Fan Mode | 49 |
| 1.5 Cooling Mode..... | 49 |
| 1.6 Heating Mode (Heat pump units)..... | 49 |
| 1.7 Auto-mode..... | 50 |
| 1.8 Drying Mode..... | 50 |
| 1.9 Forced Operation Function | 50 |
| 1.10 Sleep Function | 51 |
| 1.11 Auto-restart Function..... | 51 |
| 1.12 Refrigerant Leakage Detection..... | 51 |
| 1.13 Ionizer/Plasma (for some models) | 51 |
| 1.14 8°C Heating (Optional)..... | 51 |
| 1.15 Self Clean (Optional)..... | 51 |
| 1.16 Follow Me (Optional)..... | 51 |
| 2. Remote Controller Functions | 52 |
| 2.1 Infrared Wireless Remote Controller | 52 |

1. Operation Modes and Functions

1.1 Abbreviation

Unit element abbreviations

| Abbreviation | Element |
|--------------|--------------------------------|
| T1 | Indoor room temperature |
| T2 | Coil temperature of evaporator |
| T3 | Coil temperature of condenser |
| T4 | Outdoor ambient temperature |
| TS | Set temperature |
| Tsc | Adjusted setting temperature |

1.2 Safety Features

Compressor three-minute delay at restart

Compressor functions are delayed for up to one minute upon the first startup of the unit, and are delayed for up to three minutes upon subsequent unit restarts.

Zero crossing detection error protection(Except for DC fan units)

If AC can not detect zero crossing signal for 4 minutes or the zero crossing signal time interval is not correct, the unit will stop and the LED will display the failure. The correct zero crossing signal time interval should be between 6-13ms.

Automatic shutoff based on fan speed

If the indoor fan speed registers below 300RPM for an extended period of time, the unit ceases operation and the corresponding error code is displayed on the indoor unit.

Indoor fan delayed operation

- When the unit starts, the louver is automatically activated and the indoor fan will operate after a period of 4 seconds.
- If the unit is in heating mode, the indoor fan is regulated by the anti-cold wind function.

Sensor redundancy and automatic shutoff

If one temperature sensor malfunctions, the air conditioner ceases operation.

Refrigerant leakage detection

This function is active only when cooling mode is selected. It will detect if the compressor is being damaged by refrigerant leakage or by compressor overload. This is measured using the coil temperature of evaporator T2 when the compressor is in operation.

1.3 Digital Display

Unit display functions

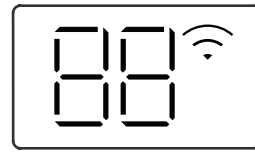

Display A

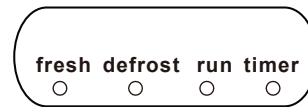

Display B

| Display | Function |
|---------|--|
| fresh | Fresh(available on select units only) |
| defrost | Defrost |
| run | When the unit is on |
| timer | When TIMER is on |
| | WiFi control (available on select units only) |
| | Temperature |
| | Activation of Timer ON, Fresh, Swing, Turbo, or Silent |
| | Cancellation of Timer OFF, Fresh, Swing, Turbo, or Silent |
| | Defrost |
| | Active Clean(For Inverter split type) or self-cleaning(For Fixed-speed type) |
| | Heating in room temperature under 8°C |

Note: Please select the display function according to your purchase product.

1.4 Fan Mode

When fan mode is activated:

- The outdoor fan and compressor are stopped.
- Temperature control is disabled and no temperature setting is displayed.
- The indoor fan speed can be set to high, medium, low, or auto.
- The louver operations are identical to those in cooling mode.
- Auto fan: In fan-only mode, AC operates the same as auto fan in cooling mode with the temperature set at 24°C(75.2°F).

1.5 Cooling Mode

1.5.1 Compressor Control

- When indoor room temperature T1 is lower than setting value, the compressor and outdoor fan cease operation.

1.5.2 Indoor Fan Control

- In cooling mode, the indoor fan operates continuously. The fan speed can be set to high, medium, low, turbo or auto.
- The auto fan acts as below rules:

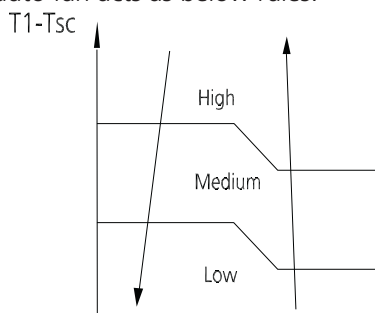

1.5.3 Outdoor Fan Control

Outdoor units just have one single fan speed. The operation of outdoor fan is consistent with the operation of compressor. Except the following situations:

- Condenser high temperature protection
- Current protection

1.5.4 Evaporator Temperature Protection

When evaporator temperature drops below a configured value, the compressor and outdoor fan cease operation.

1.6 Heating Mode (Heat pump units)

1.6.1 Compressor Control

Once the compressor starts up, it will keep running for 7 minutes, then indoor room temperature T1 is higher than setting value, the compressor and outdoor fan cease operation.

1.6.2 Indoor Fan Control:

- When the compressor is on, the indoor fan speed can be set to high, medium, low, or auto. And the anti-cold wind function has the priority.
- Anti-cold air function
 - When indoor unit coil temperature T2 is low, the anti-cold air function will start and the indoor fan is controlled by indoor unit coil temperature T2.

For 18K and below models:

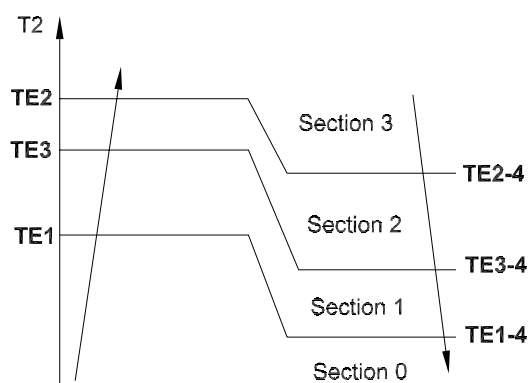

Section 0: Indoor fan runs at the breeze speed after the compressor is on for 2 minutes

Section 1: Low speed

Section 2: Medium speed

Section 3: No limit

For above 18K models:

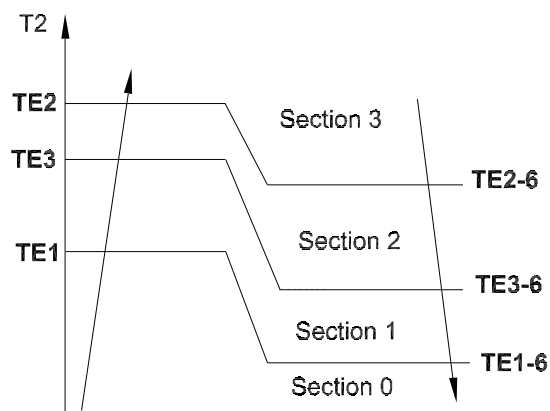

Section 0: Indoor fan runs at the breeze after the compressor is on for 2 minutes, after 2 minutes, if $T2 < TE1-6$, the fan will cease operation. After that, the indoor fan keeps off.

Section 1: Breeze speed

Section 2: Low speed

Section 3: NO limit

- Auto fan action in heating mode:

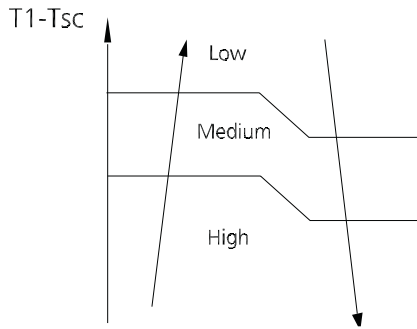

1.6.3 Outdoor Fan Control:

Outdoor units just have one single fan speed. The operation of outdoor fan is consistent with the operation of compressor. Except the following situations:

- Evaporator high temperature protection
- Defrosting
- Current protection.

1.6.4 Defrosting mode

- The unit enters defrosting mode according to the temperature difference between T2 and T1, as well as the compressor runtime.
- In defrosting mode, the compressor continues to run, the indoor and outdoor motor will cease operation, the defrost light of the indoor unit will turn on, and the “df” symbol is displayed.
- If any one of the following conditions is satisfied, defrosting ends and the machine switches to normal heating mode:
 - Compressor current is over than $I_{defrost}$ and lasts for 7s
 - The defrosting time has reached the setting value.
 - $T2 \geq 2^{\circ}C(3.6^{\circ}F)$ after entering defrosting mode for 3 minutes.
 - After entering defrosting mode for 2 minutes, check the value of T2. The minimum temperature of T2 is marked as T2min. If $T2 - T2min \geq 2^{\circ}C(3.6^{\circ}F)$ during the following 4 minutes, AC will exit defrosting mode(if $T2 \leq -15^{\circ}C(5^{\circ}F)$, considers it as $-15^{\circ}C(5^{\circ}F)$).

1.6.5 Evaporator Temperature Protection

When the evaporator temperature exceeds a preset protection value, the compressor ceases operation.

1.7 Auto-mode

- This mode can be selected with the remote controller and the setting temperature can be changed between $17^{\circ}C \sim 30^{\circ}C(62^{\circ}F \sim 86^{\circ}F)$.
- In auto mode, the machine selects cooling, heating, or fan-only mode on the basis of ΔT ($\Delta T = T1 - TS$).

| ΔT | Running mode |
|--|--------------|
| $\Delta T > 2^{\circ}C(3.6^{\circ}F)$ | Cooling |
| $-3^{\circ}C(-5.4^{\circ}F) \leq \Delta T \leq 2^{\circ}C(3.6^{\circ}F)$ | Fan-only |
| $\Delta T < -3^{\circ}C(-5.4^{\circ}F)$ | Heating* |

Heating*: In auto mode, cooling only models run the fan

- Indoor fan will run at auto fan speed.
- The unit will choose running mode, when
 - received the auto signal from the remote controller;
 - forced-auto mode by pressing manual button;
 - time on to auto mode;
 - the compressor doesn't start in 20 minutes when a running mode is set in auto.

1.8 Drying Mode

- Compressor will run for 10 minutes and be off for 5 minutes and loop again and again
- Indoor fan speed is fixed at low and can't be changed. The louver angle is the same as in cooling mode.
- All protections are active and the same as that in cooling mode.
- Low indoor room temperature protection
 - If $T1 < 10^{\circ}C(50^{\circ}F)$, the compressor ceases operation until $T1 > 13^{\circ}C(55.4^{\circ}F)$.

1.9 Forced Operation Function

Press the AUTO/COOL button, the AC will run as below sequence:

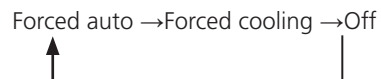

- Forced cooling mode:

The compressor and outdoor fan continue to run and the indoor fan runs at low speed. After running for 30 minutes, the AC will switch to auto mode with a preset temperature of $24^{\circ}C(76^{\circ}F)$.

- Forced auto mode:

Forced auto mode operates the same as normal auto mode with a preset temperature of $24^{\circ}C(76^{\circ}F)$.

- The unit exits forced operation when it receives the following signals:

- Switch on
- Switch off
- Timer on
- Timer off
- Changes in:
 - mode
 - fan speed
 - sleep mode
 - Follow me

1.10 Sleep Function

- The sleep function is available in cooling, heating, or auto mode.
- The operational process for sleep mode is as follows:
 - When cooling, the temperature rises 1°C(2°F) (to not higher than 30°C(86°F)) every hour. After 2 hours, the temperature stops rising and the indoor fan is fixed at low speed.
 - When heating, the temperature decreases 1°C(2°F) (to not lower than 17°C(62.6°F)) every hour. After 2 hours, the temperature stops decreasing and the indoor fan is fixed at low speed. Anti-cold wind function takes priority.
- The operating time for sleep mode is 8 hours, after which, the unit exits this mode but does not switch off.

1.11 Auto-restart Function

- The indoor unit has an auto-restart module that allows the unit to restart automatically. The module automatically stores the current settings (not including the swing setting) and, in the case of a sudden power failure, will restore those setting automatically within 3 minutes after power returns.
- If the unit was in forced cooling mode, it will run in this mode for 30 minutes and turn to auto mode with temperature set to 24°C(76°F).
- If there is a power failure while the unit is running, the compressor starts 3 minutes after the unit restarts. If the unit was already off before the power failure, the compressor starts 1 minute after the unit restarts.

1.12 Refrigerant Leakage Detection

With this new technology, the display area will show "EL 0C" when the outdoor unit detects refrigerant leakage.

1.13 Ionizer/Plasma (for some models)

When AC powers on and indoor fan is on, press "Fresh" on the remote control to enable the IONIZER function. While this function is active, the Ionizer/Plasma Dust Collector(depending on models) is energized and will help to remove pollen and impurities from the air.

1.14 8°C Heating (Optional)

In heating mode, the temperature can be set to as low as 8°C, preventing the indoor area from freezing if unoccupied during severe cold weather.

1.15 Self Clean (Optional)

- If you press "Self Clean" when the unit is in cooling or drying mode:
 - For cooling models, the indoor unit will run in low fan mode for a certain time, then ceases operation.
 - For heat pump models, the indoor unit will run in fan-only mode, then low heat, and finally in fan-only mode.
- Self Clean keeps the indoor unit dry and prevents mold growth.
- When match with multi outdoor unit, this function is disabled.

1.16 Follow Me (Optional)

- If you press "Follow Me" on the remote, the indoor unit will beep. This indicates the follow me function is active.
- Once active, the remote control will send a signal every 3 minutes, with no beeps. The unit automatically sets the temperature according to the measurements from the remote control.
- The unit will only change modes if the information from the remote control makes it necessary, not from the unit's temperature setting.
- If the unit does not receive a signal for 7 minutes or you press "Follow Me," the function turns off. The unit regulates temperature based on its own sensor and settings.

2. Remote Controller Functions

2.1 Infrared Wireless Remote Controller

2.1.1. KIC-111H

| | |
|------------------------|---------------------------------|
| Model | KIC-111H |
| Rated Voltage | 3.0V(Dry batteries R03/LR03×2) |
| Signal Receiving Range | 8m |
| Environment | -5°C~60°C(23°F~140°F) |

Quick Start Guide

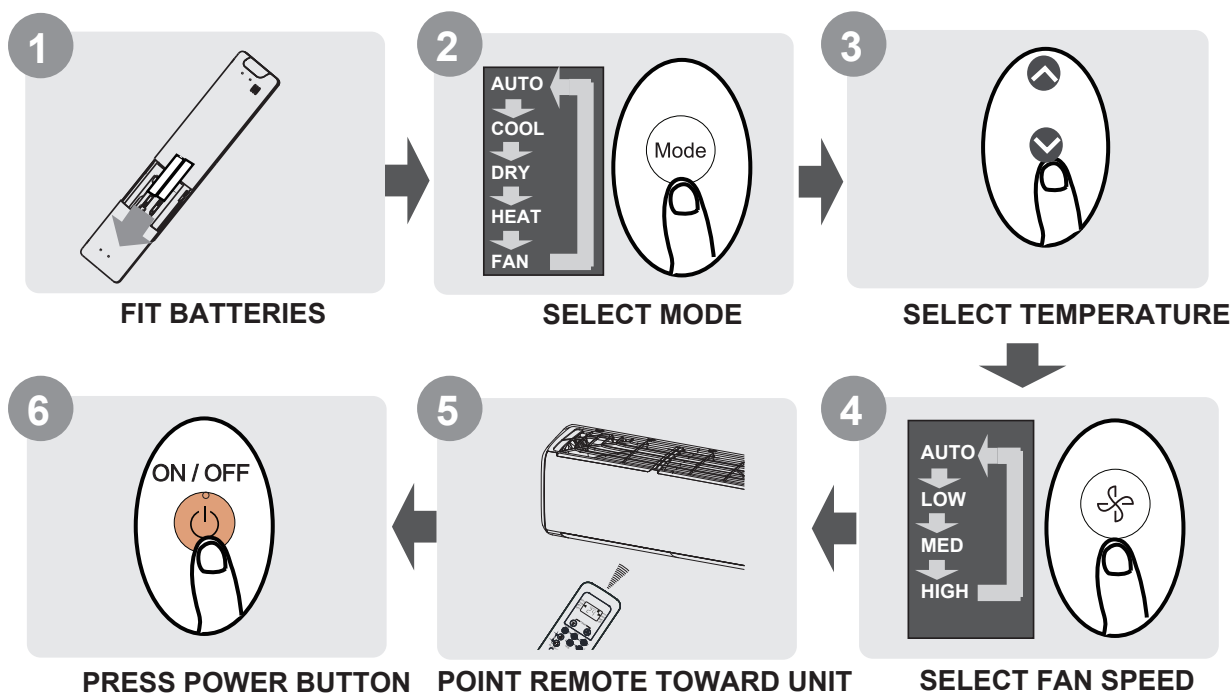

NOT SURE WHAT A FUNCTION DOES?

Refer to the **How to Use Basic Functions** and **How to Use Advanced Functions** sections of this manual for a detailed description of how to use your air conditioner.

SPECIAL NOTE

- Button designs on your unit may differ slightly from the example shown.
- If the indoor unit does not have a particular function, pressing that function's button on the remote control will have no effect.
- When there are wide differences between "Remote controller Manual" and "USER'S MANUAL" on function description, the description of "USER'S MANUAL" shall prevail.

Handling the Remote Controller

Inserting and Replacing Batteries

Your air conditioning unit may come with two batteries (some units). Put the batteries in the remote control before use.

1. Slide the back cover from the remote control downward, exposing the battery compartment.
2. Insert the batteries, paying attention to match up the (+) and (-) ends of the batteries with the symbols inside the battery compartment.
3. Slide the battery cover back into place.

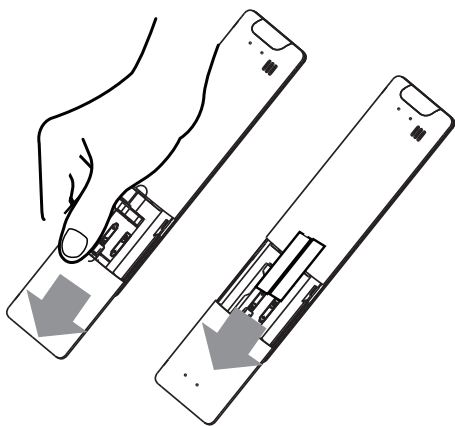

BATTERY NOTES

For optimum product performance:

- Do not mix old and new batteries, or batteries of different types.
- Do not leave batteries in the remote control if you don't plan on using the device for more than 2 months.



BATTERY DISPOSAL

Do not dispose of batteries as unsorted municipal waste. Refer to local laws for proper disposal of batteries.

TIPS FOR USING REMOTE CONTROL

- The remote control must be used within 8 meters of the unit.
- The unit will beep when remote signal is received.
- Curtains, other materials and direct sunlight can interfere with the infrared signal receiver.
- Remove batteries if the remote will not be used more than 2 months.

NOTES FOR USING REMOTE CONTROL

The device could comply with the local national regulations.

- In Canada, it should comply with CAN ICES-3(B)/NMB-3(B).
- In USA, this device complies with part 15 of the FCC Rules. Operation is subject to the following two conditions:
 - (1) This device may not cause harmful interference, and
 - (2) this device must accept any interference received, including interference that may cause undesired operation.

This equipment has been tested and found to comply with the limits for a Class B digital device, pursuant to part 15 of the FCC Rules. These limits are designed to provide reasonable protection against harmful interference in a residential installation. This equipment generates, uses and can radiate radio frequency energy and, if not installed and used in accordance with the instructions, may cause harmful interference to radio communications. However, there is no guarantee that interference will not occur in a particular installation. If this equipment does cause harmful interference to radio or television reception, which can be determined by turning the equipment off and on, the user is encouraged to try to correct the interference by one or more of the following measures:

- Reorient or relocate the receiving antenna.
- Increase the separation between the equipment and receiver.
- Connect the equipment into an outlet on a circuit different from that to which the receiver is connected.
- Consult the dealer or an experienced radio/TV technician for help.
- Changes or modifications not approved by the party responsible for compliance could void user's authority to operate the equipment.

Buttons and Functions

Before you begin using your new air conditioner, make sure to familiarize yourself with its remote control. The following is a brief introduction to the remote control itself. For instructions on how to operate your air conditioner, refer to the **How to Use Basic Functions** section of this manual.

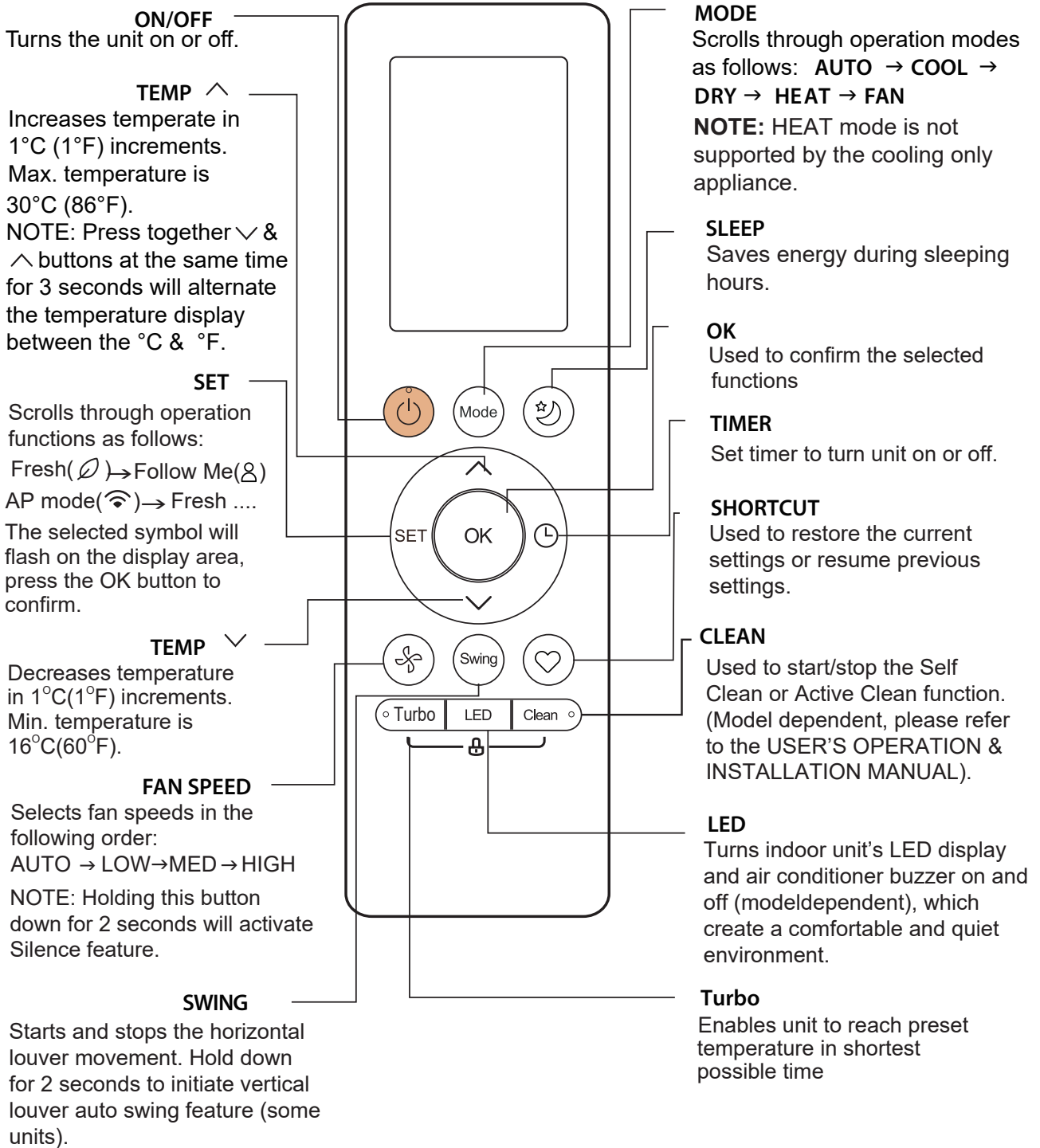

Model: KIC-111H

Remote Screen Indicators

Information are displayed when the remote controller is power up.

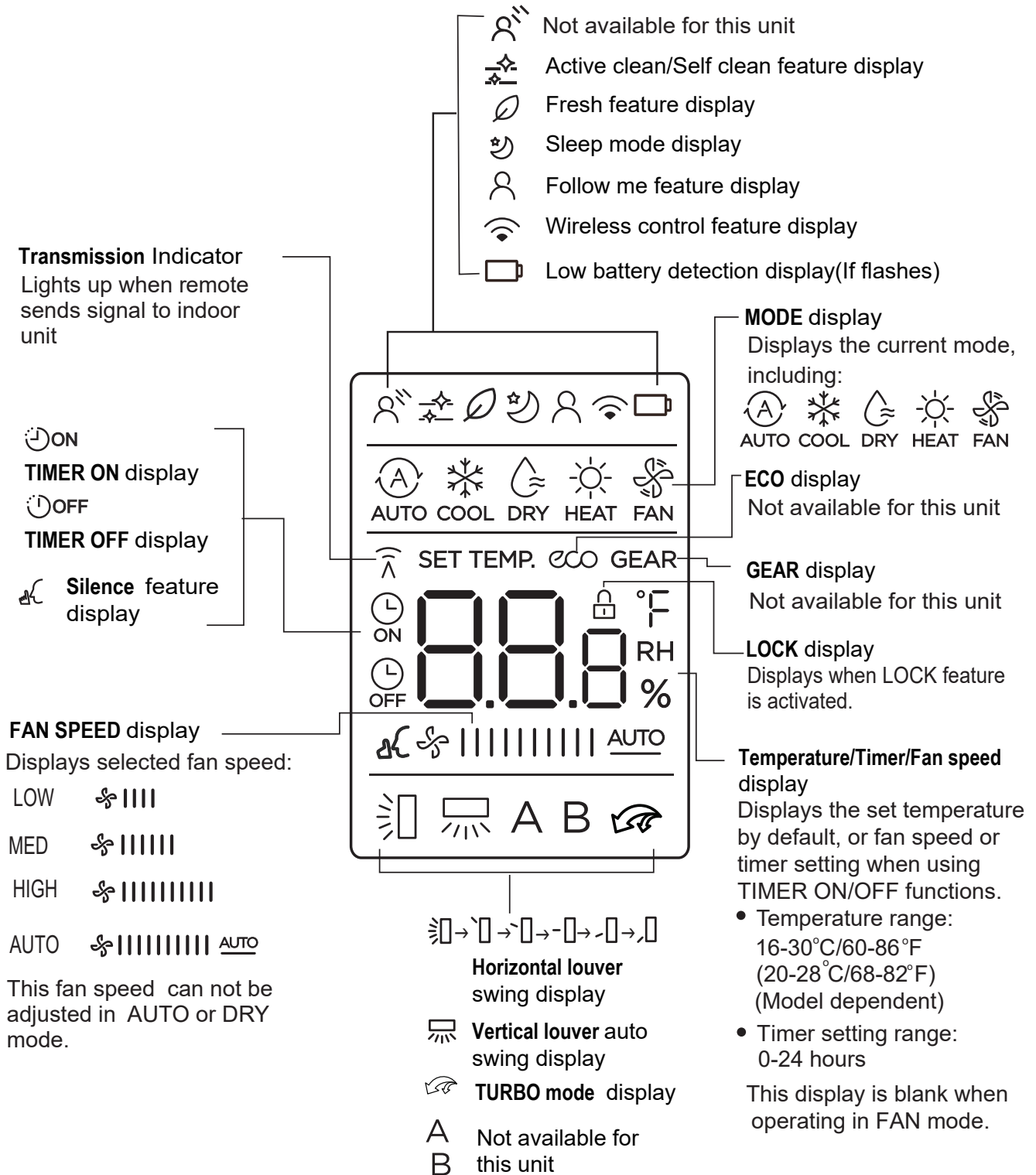

Note:

All indicators shown in the figure are for the purpose of clear presentation. But during the actual operation, only the relative function signs are shown on the display window.

How to Use Basic Functions

Basic operation

ATTENTION! Before operation, please ensure the unit is plugged in and power is available.

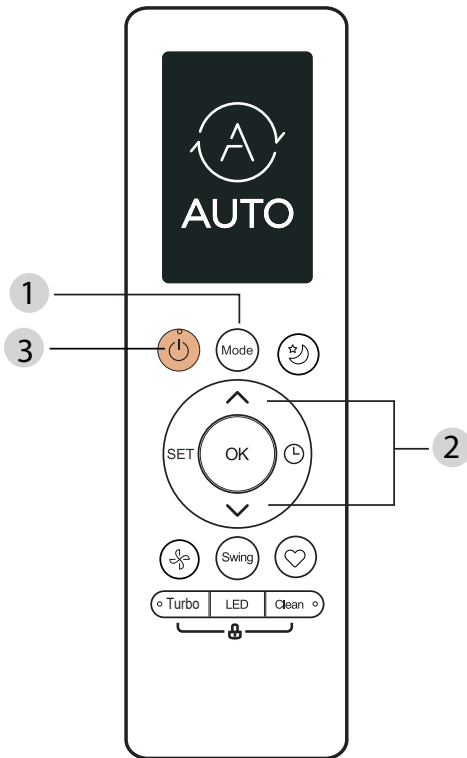

COOL Mode

1. Press the **MODE** button to select **COOL** mode.
2. Set your desired temperature using the **TEMP** \wedge or **TEMP** \vee button.
3. Press **FAN** button to select the fan speed: AUTO, LOW, MED or HIGH.
4. Press the **ON/OFF** button to start the unit.

SETTING TEMPERATURE

The operating temperature range for units is 16-30°C (60-86°F)/20-28°C(68-82°F). You can increase or decrease the set temperature in 1°C (1°F) increments.

AUTO Mode

In AUTO mode, the unit will automatically select the COOL, FAN, or HEAT operation based on the set temperature.

1. Press the **MODE** button to select **AUTO**.
2. Set your desired temperature using the **TEMP** \wedge or **TEMP** \vee button.
3. Press the **ON/OFF** button to start the unit.

NOTE: FAN SPEED can't be set in AUTO mode.

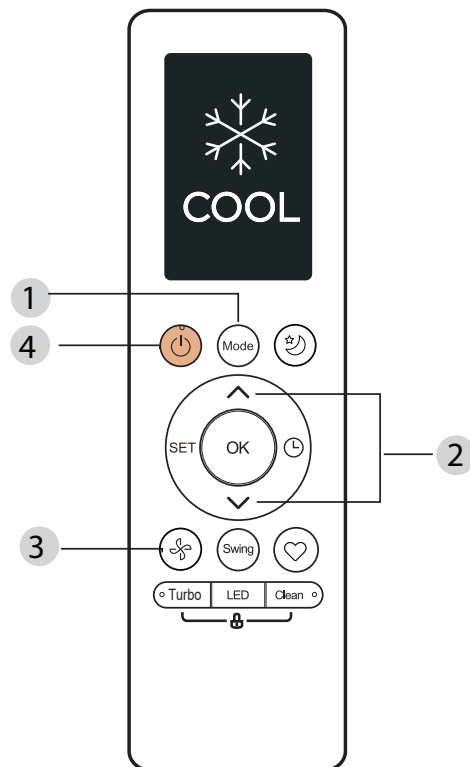

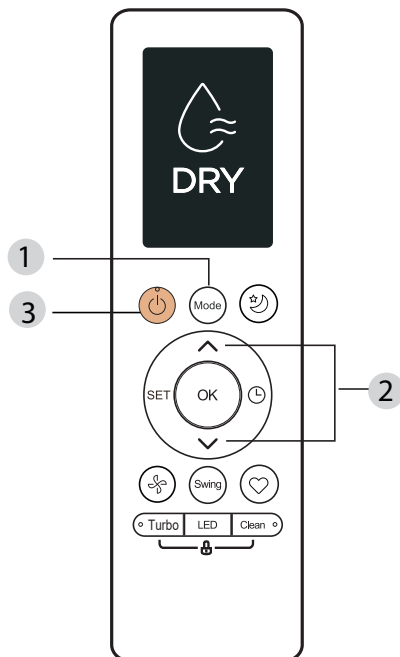

DRY Mode (dehumidifying)

1. Press the **MODE** button to select **DRY**.
2. Set your desired temperature using the **TEMP ^** or **TEMP v** button.
3. Press the **ON/OFF** button to start the unit.

NOTE:FAN SPEED cannot be changed in DRY mode.

FAN Mode

1. Press the **MODE** button to select **FAN** mode.
2. Press **FAN** button to select the fan speed: AUTO, LOW, MED or HIGH.
3. Press the **ON/OFF** button to start the unit.

NOTE:You can't set temperature in FAN mode. As a result, your remote control's LCD screen will not display temperature.

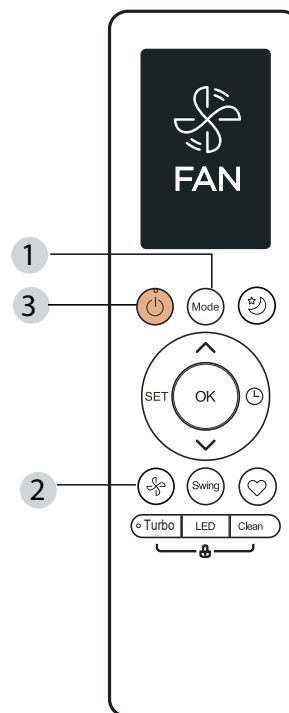

HEAT Mode

1. Press the **MODE** button to select **HEAT** mode.
2. Set your desired temperature using the **TEMP ^** or **TEMP v** button.
3. Press **FAN** button to select the fan speed: AUTO, LOW, MED or HIGH.
4. Press the **ON/OFF** button to start the unit.

NOTE: As outdoor temperature drops, the performance of your unit's HEAT function may be affected. In such instances, we recommend using this air conditioner in conjunction with other heating appliances.

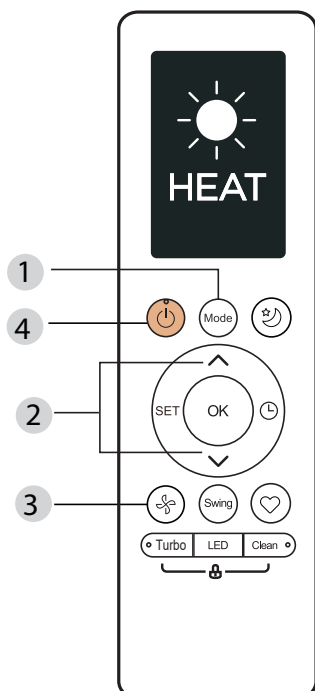

Setting the TIMER

TIMER ON/OFF - Set the amount of time after which the unit will automatically turn on/off.

TIMER ON setting

Press **TIMER** button to initiate the ON time sequence.



Press **Temp. up or down** button for multiple times to set the desired time to turn on the unit.



Point remote to unit and wait 1sec, the **TIMER ON** will be activated.



TIMER OFF setting

Press **TIMER** button to initiate the OFF time sequence.



Press **Temp. up or down** button for multiple times to set the desired time to turn off the unit.



Point remote to unit and wait 1sec, the **TIMER OFF** will be activated.



NOTE:

- When setting the **TIMER ON** or **TIMER OFF**, the time will increase by 30 minutes increments with each press, up to 10 hours. After 10 hours and up to 24, it will increase in 1 hour increments. (For example, press 5 times to get 2.5h, and press 10 times to get 5h.) The timer will revert to 0.0 after 24.
- Cancel either function by setting its timer to 0.0h.

TIMER ON & OFF setting(example)

Keep in mind that the time periods you set for both functions refer to hours after the current time.

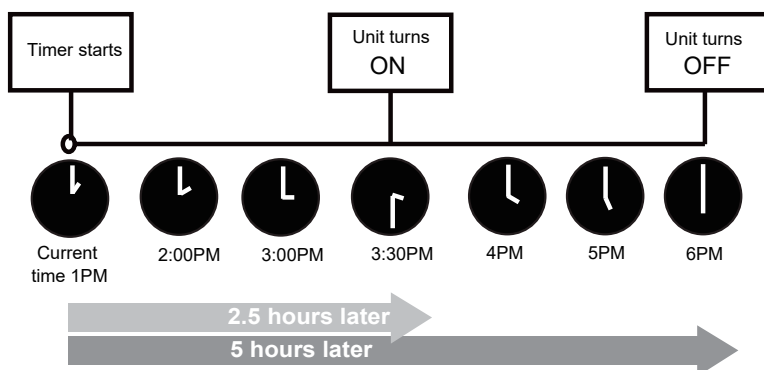
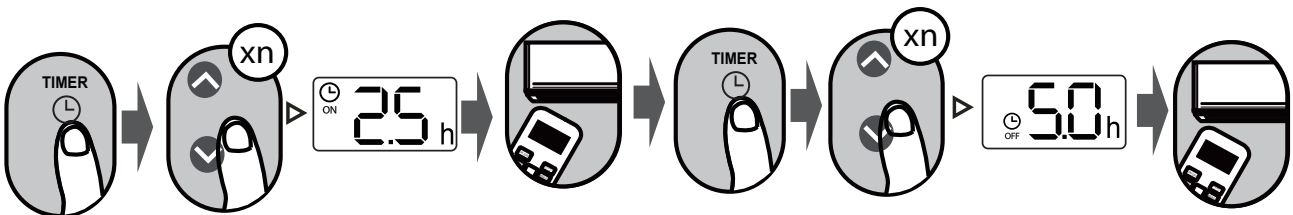

Example: If current timer is 1:00PM, to set the timer as above steps, the unit will turn on 2.5h later (3:30PM) and turn off at 6:00PM.

How to Use Advanced Functions

Swing function

Press Swing button

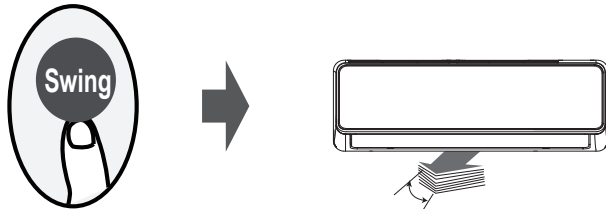

The horizontal louver will swing up and down automatically when pressing Swing button. Press again to make it stop.

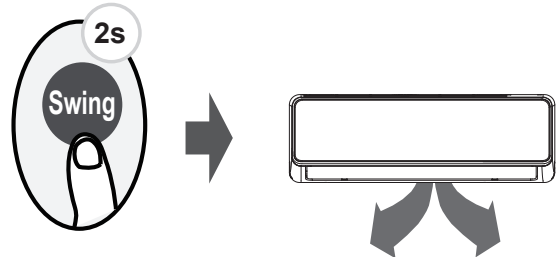

Keep pressing this button more than 2 seconds, the vertical louver swing function is activated. (Model dependent)

Airflow direction

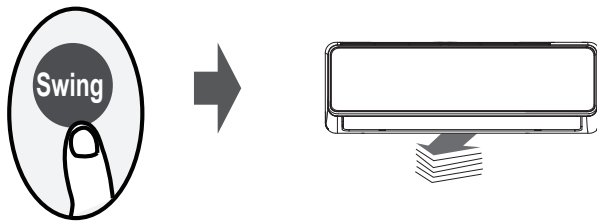

If continue to press the SWING button, five different airflow directions can be set. The louver can be move at a certain range each time you press the button. Press the button until the direction you prefer is reached.

SHORTCUT function

Press SHORTCUT button

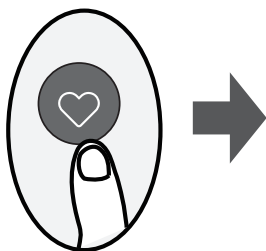

Push this button when remote controller is on, the system will automatically revert back to the previous settings including operating mode, setting temperature, fan speed level and sleep feature (if activated).

If pushing more than 2 seconds, the system will automatically restore the current operation settings including operating mode, setting temperature, fan speed level and sleep feature (if activated).

TURBO Function

Press TURBO button

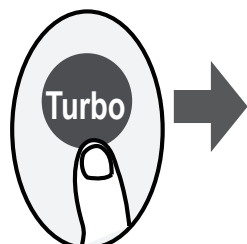

When you select Turbo feature in COOL mode, the unit will blow cool air with strongest wind setting to jump-start the cooling process.

When you select Turbo feature in HEAT mode, for units with Electric heat elements, the Electric HEATER will activate and jump-start the heating process.

LED DISPLAY

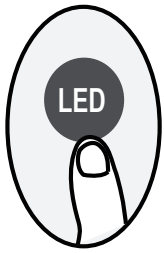

Press LED button

Press this button to turn on and turn off the display on the indoor unit.

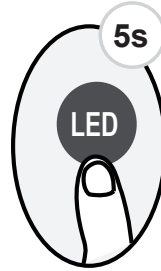

Press this button more than 5 seconds (some units)

Keep pressing this button more than 5 seconds, the indoor unit will display the actual room temperature. Press more than 5 seconds again will revert back to display the setting temperature.

LOCK function

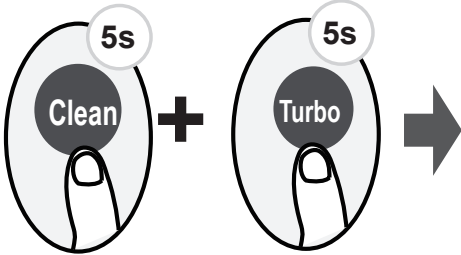

Press together **Clean** button and **Turbo** button at the same time more than 5 seconds to activate Lock function. All buttons will not response except pressing these two buttons for two seconds again to disable locking.

Silence function



Keep pressing Fan button for more than 2 seconds to activate/disable Silence function (some units).

Due to low frequency operation of compressor, it may result in insufficient cooling and heating capacity. Press ON/OFF, Mode, Sleep, Turbo or Clean button while operating will cancel silence function.

SLEEP Function

Press SLEEP button

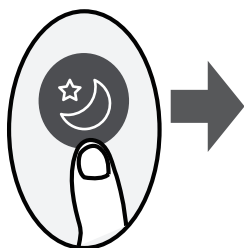

The SLEEP function is used to decrease energy while you sleep (and don't need the same temperature settings to stay comfortable). This function can only be activated via remote control.

For the details, please see "sleep operation" in "USER'S MANUAL".

Note: The SLEEP function is not available in FAN or DRY mode.

FP function

Press this button 2 times during one second under HEAT Mode and setting temperature of 16°C/60°F or 20°C/68°F (for model of RG10B10(B2)/BGEF).

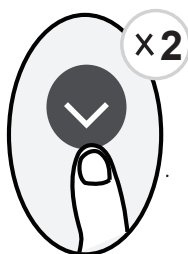

The unit will operate at high fan speed (while compressor on) with temperature automatically set to 8°C/46°F.

Note: This function is for heat pump air conditioner only.

Press this button 2 times under HEAT Mode and setting temperature of 16°C/60°F or 20°C/68°F (for model of RG10B10(B2)/BGEF) to activate the FP function. Press On/Off, Sleep, Mode, Fan and Temp. button while operating will cancel this function.

SET function

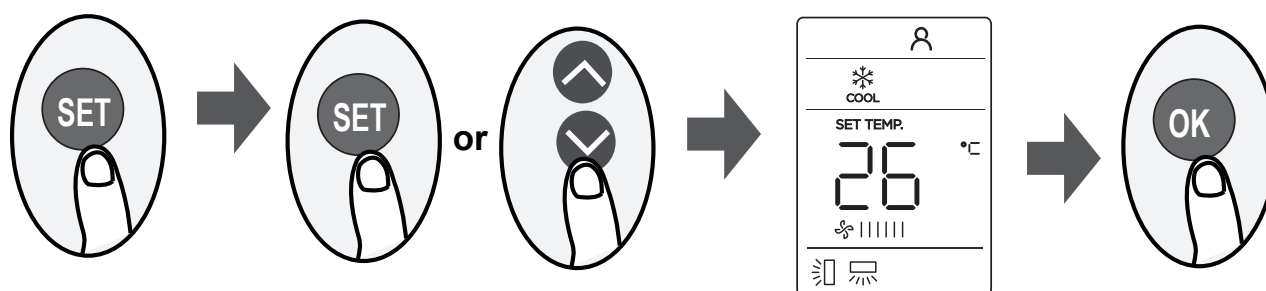

- Press the SET button to enter the function setting, then press SET button or TEMP \downarrow or TEMP \uparrow button to select the desired function. The selected symbol will flash on the display area, press the OK button to confirm.
- To cancel the selected function, just perform the same procedures as above.
- Press the SET button to scroll through operation functions as follows:
 Fresh* (🍃) → Follow Me (👤) → AP mode (📶)
 [*]: If your remote controller has Fresh button, you can not use the SET button to select Fresh feature.

FRESH function() (some units) :

When the FRESH function is initiated, the Ionizer/Plasma Dust Collector(depending on models) is energized and will help to remove pollen and impurities from the air

Follow me function() :

The FOLLOW ME function enables the remote control to measure the temperature at its current location and send this signal to the air conditioner every 3 minutes interval. When using AUTO, COOL or HEAT modes, measuring ambient temperature from the remote control(instead of from the indoor unit itself) will enable the air conditioner to optimize the temperature around you and ensure maximum comfort.

NOTE: Press and hold Turbo button for seven seconds to start/stop memory feature of Follow Me function

- If the memory feature is activated, “ **On** ” displays for 3 seconds on the screen.
- If the memory feature is stopped, “ **OF** ” displays for 3 seconds on the screen.
- While the memory feature is activated, press the ON/OFF button, shift the mode or power failure will not cancel the Follow me function.

AP function()(some units) :

Choose AP mode to do wireless network configuration. For some units, it doesn't work by pressing the SET button. To enter the AP mode, continuously press the LED button seven times in 10 seconds.







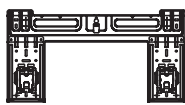
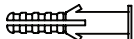

Installation

Contents

Page

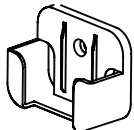
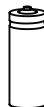
| | |
|---|----|
| Accessoires..... | 64 |
| 1. Installation Overview-Indoor Unit..... | 65 |
| 2. Location Selection..... | 66 |
| 3. Indoor Unit Installation | 67 |
| 4. Outdoor Unit Installation (Side Discharge Unit)..... | 72 |
| 5. Refrigerant Pipe Installation | 73 |
| 6. Vacuum Drying and Leakage Checking | 75 |
| 7. Additional Refrigerant Charge..... | 76 |
| 8. Electrical and Gas Leak Checks | 76 |
| 9. Test Operation..... | 77 |

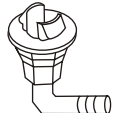
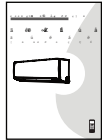
Accessoires

| Name | Shape | Quantity | |
|---|---|--------------------------------------|--|
| Mounting plate |  | 1 | |
| Clip anchor |  | 5-8(depending on models) | |
| Mounting plate fixing screw ST3.9 X 25 |  | 5-8(depending on models) | |
| Remote controller |  | 1 | |
| Fixing screw for remote controller holder ST2.9 x 10 |  | 2 | Optional Parts |
| Remote controller holder |  | 1 | |
| Dry battery AAA.LR03 (not included) |  | 2 | |
| Seal |  | 1(for cooling & heating models only) | |
| Drain joint |  | | |
| Manual |  | 2-3 | |
| Small Filter(Need to be installed on the back of main air filter by the authorized technician while installing the machine) |  | 1~2(depending on models) | |
| Connecting pipe assembly | Liquid side | Φ6.35 (1/4in) | Parts you must purchase. Consult the dealer about the pipe size. |
| | | Φ9.52 (3/8in) | |
| | Gas side | Φ9.52 (3/8in) | |
| | | Φ12.7 (1/2in) | |
| | | Φ16 (5/8in) | |
| | | Φ19 (3/4in) | |

1. Installation Overview-Indoor Unit

Installation Order

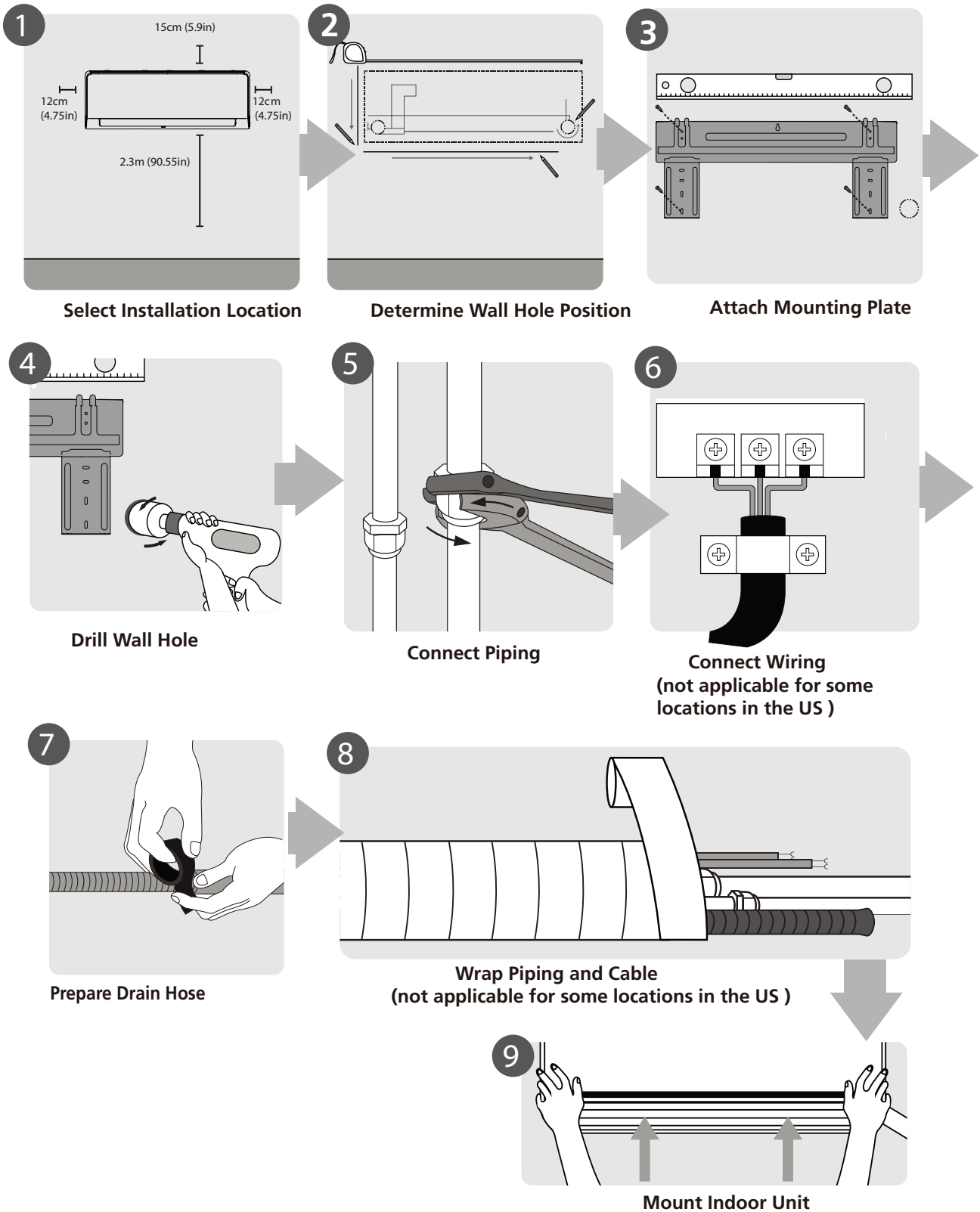

2. Location selection

2.1 Unit location selection can refer to installation manual.

2.2 DO NOT install the unit in the following locations:

- Where oil drilling or fracking is taking place.
- Coastal areas with high salt content in the air.
- Areas with caustic gases in the air, such as near hot springs.
- Areas with power fluctuations, such as factories.
- Enclosed spaces, such as cabinets.
- Areas with strong electromagnetic waves.
- Areas that store flammable materials or gas.
- Rooms with high humidity, such as bathrooms or laundry rooms.
- If possible, DO NOT install the unit where it is exposed to direct sunlight.

2.3 The minimum distance between the outdoor unit and walls described in the installation guide does not apply to airtight rooms. Be sure to keep the unit unobstructed in at least two of the three directions (M, N, P)

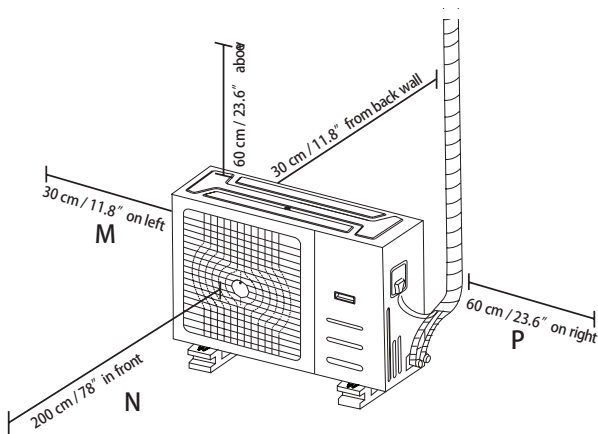

2.4 Rows of series installation

The relations between H, A and L are as follows.

| | L | A |
|-------|----------------------|-----------------------|
| L ≤ H | $L \leq 1/2H$ | 25 cm / 9.8" or more |
| | $1/2H < L \leq H$ | 30 cm / 11.8" or more |
| L > H | Can not be installed | |

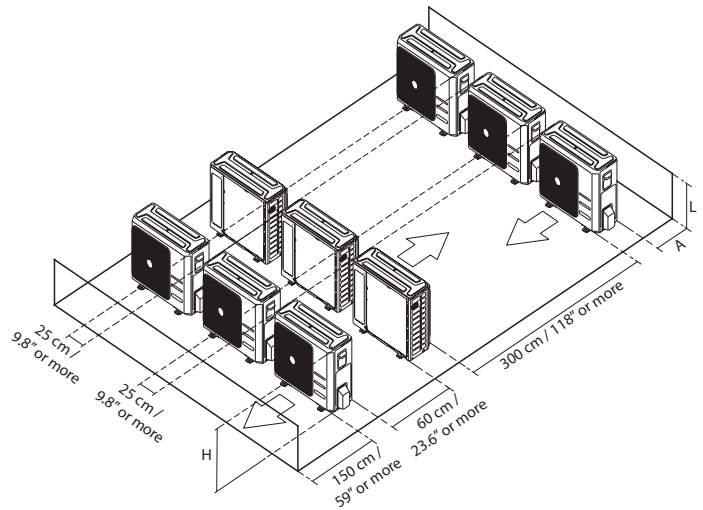

DO NOT install the rows of series like following figure.

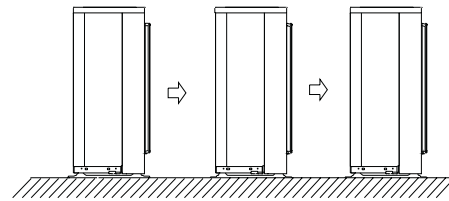

2.5 If the unit is exposed to heavy wind:

- Install unit so that air outlet fan is at a 90° angle to the direction of the wind. If needed, build a barrier in front of the unit to protect it from extremely heavy winds.

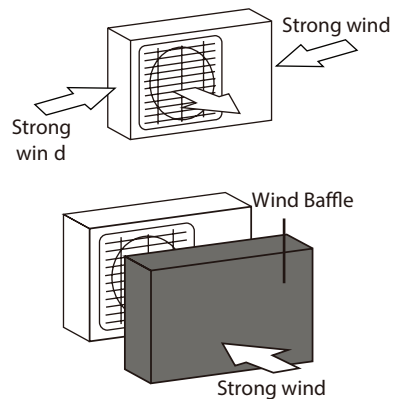

2.6 If the unit is frequently exposed to heavy rain or snow:

Build a shelter above the unit to protect it from the rain or snow. Be careful not to obstruct air flow around the unit.

2.7 If the unit is frequently exposed to salty air (seaside):

Use outdoor unit that is specially designed to resist corrosion.

3. Indoor Unit Installation

3.1 Service space for indoor unit

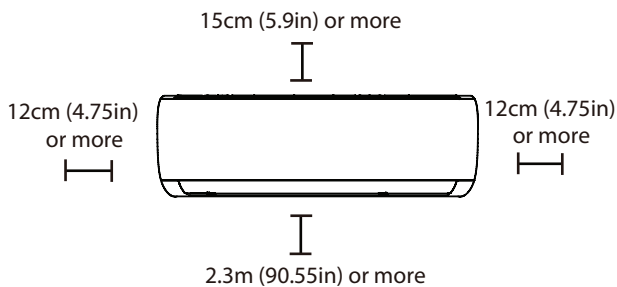

3.2 Attach mounting plate to wall

- **The mounting plate is the device on which you will mount the indoor unit.**

1. Remove the screw that attaches the mounting plate to the back of the indoor unit.

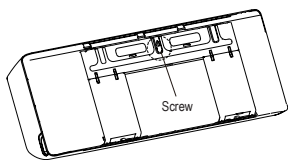

2. Place the mounting plate against the wall in a location that meets the standards in the Select Installation Location step. (See Mounting Plate Dimensions for detailed information on mounting plate sizes.)

3. Drill holes for mounting screws in places that:

- have studs and can support the weight of the unit.
- correspond to screw holes in the mounting plate.

4. Secure the mounting plate to the wall with the screws provided.

5. Make sure that mounting plate is flat against the wall.

- **Mounting plate dimensions**

Different models have different mounting plates. For the different customization requirements, the shape of the mounting plate may be slightly different. But the installation dimensions are the same for the same size of indoor unit.

Correct orientation of Mounting Plate

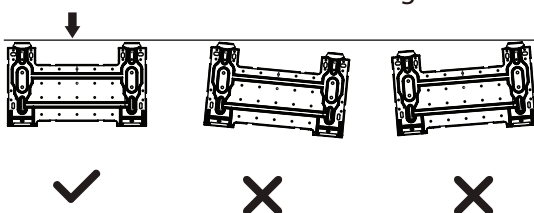

KSGA21-26HFRN1

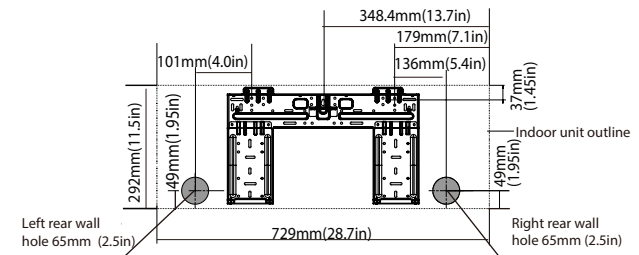

KSGA35HFRN1

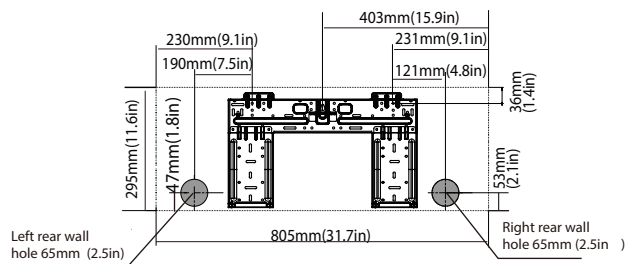

KSGA53HFRN1

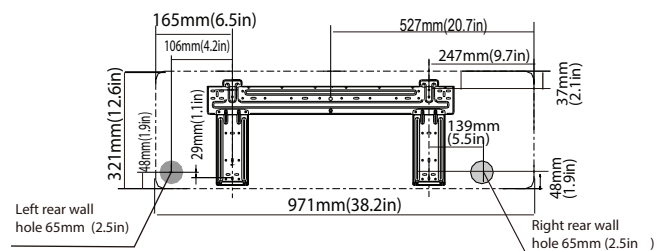

KSGA70HFRN1

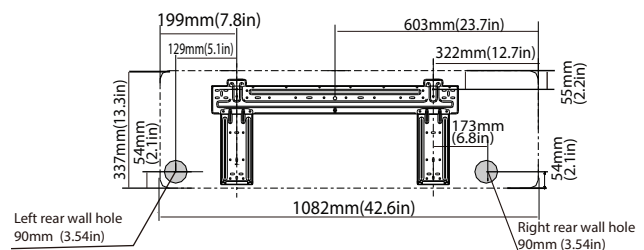

- **Note for concrete or brick walls:**

If the wall is made of brick, concrete, or similar material, drill 5mm-diameter (0.2in-diameter) holes in the wall and insert the sleeve anchors provided. Then secure the mounting plate to the wall by tightening the screws directly into the clip anchors.

3.3 Drill wall hole for connective piping

You must drill a hole in the wall for refrigerant piping, the drainage pipe, and the signal cable that will connect the indoor and outdoor units.

1. Determine the location of the wall hole based on the position of the mounting plate. Refer to Mounting Plate

Dimensions.

2. Using a 65mm (2.5in) or 90mm(3.54in) (depending on models)core drill, drill a hole in the wall. Make sure that the hole is drilled at a slight downward angle, so that the outdoor end of the hole is lower than the indoor end by about 5mm to 7mm (0.2-0.27in). This will ensure proper water drainage.

3. Place the protective wall cuff in the hole. This protects the edges of the hole and will help seal it when you finish the installation process.

NOTE: When drilling the wall hole, make sure to avoid wires, plumbing, and other sensitive components.

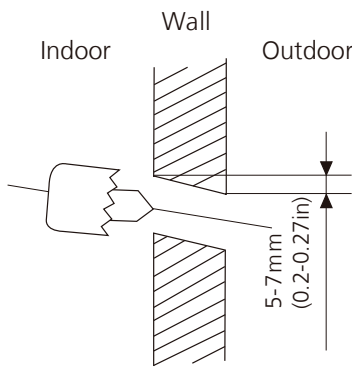

3.4 Prepare refrigerant piping

The refrigerant piping is inside an insulating sleeve attached to the back of the unit. You must prepare the piping before passing it through the hole in the wall.

1. Based on the position of the wall hole relative to the mounting plate, choose the side from which the piping will exit the unit.

2. If the wall hole is behind the unit, keep the knock-out panel in place. If the wall hole is to the side of the indoor unit, remove the plastic knock-out panel from that side of the unit.

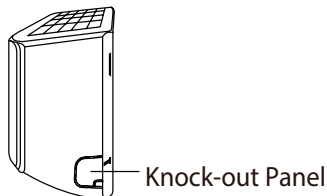

3. If existing connective piping is already embedded in the wall, proceed directly to the Connect Drain Hose step. If there is no embedded piping, connect the indoor unit's refrigerant piping to the connective piping that will join the indoor and outdoor units. Refer to the Refrigerant Piping Connection section of this manual for detailed instructions.

NOTE: Refrigerant piping can exit the indoor unit from four different angles:

- Left-hand side
- Left rear
- Right-hand side
- Right rear

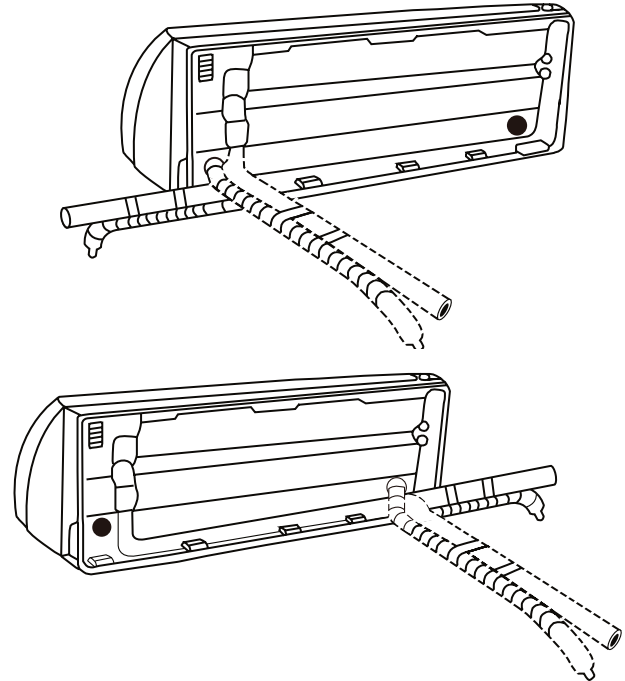

Be extremely careful not to dent or damage the piping while bending them away from the unit. Any dents in the piping will affect the unit's performance.

3.5 Connect drain hose

By default, the drain hose is attached to the left hand side of unit (when you're facing the back of the unit).

- Wrap the connection point firmly with Teflon tape to ensure a good seal and to prevent leaks.
- Remove the air filter and pour a small amount of water into the drain pan to make sure that water flows from the unit smoothly.

NOTE ON DRAIN HOSE PLACEMENT:

- Make sure to arrange the drain hose according to the following figures.

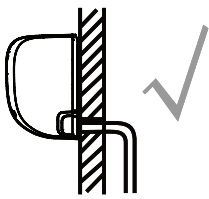
**CORRECT**

Make sure there are no kinks or dent in drain hose to ensure proper drainage.

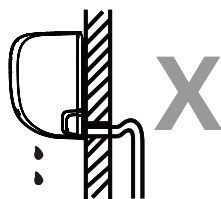
**NOT CORRECT**

Kinks in the drain hose will create water traps.

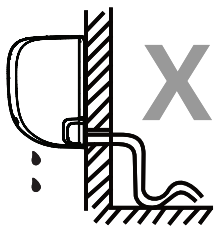
**NOT CORRECT**

Kinks in the drain hose will create water traps.

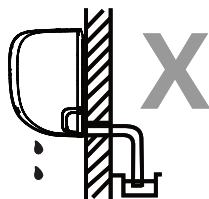
**NOT CORRECT**

Do not place the end of the drain hose in water or in containers that collect water. This will prevent proper drainage.

PLUG THE UNUSED DRAIN HOLE

To prevent unwanted leaks you must plug the unused drain hole with the rubber plug provided.

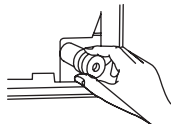
**3.6 Connect signal and power cable****3.6.1 Before performing electrical work, read these regulations**

1. All wiring must comply with local and national electrical codes, and must be installed by a licensed electrician.
2. All electrical connections must be made according to the Electrical Connection Diagram located on the panels of the indoor and outdoor units.
3. If there is a serious safety issue with the power supply, stop work immediately. Explain your reasoning to the client, and refuse to install the unit until the safety issue is properly resolved.
4. Power voltage should be within 90-110% of rated voltage. Insufficient power supply can cause malfunction, electrical shock, or fire.
5. If connecting power to fixed wiring, install a surge protector and main power switch with a capacity of 1.5 times the maximum current of the unit.
6. If connecting power to fixed wiring, a switch or circuit breaker that disconnects all poles and has a contact separation of at least 1/8in (3mm) must be incorporated in the fixed wiring. The qualified technician must use an approved circuit breaker or switch.
7. Only connect the unit to an individual branch circuit outlet. Do not connect another appliance to that outlet.
8. Make sure to properly ground the air conditioner.
9. Every wire must be firmly connected. Loose wiring can cause the terminal to overheat, resulting in product malfunction and possible fire.
10. Do not let wires touch or rest against refrigerant tubing, the compressor, or any moving parts within the unit.
11. If the unit has an auxiliary electric heater, it must be installed at least 1 meter (40in) away from any combustible materials.
12. BEFORE PERFORMING ANY ELECTRICAL OR WIRING WORK, TURN OFF THE MAIN POWER TO THE SYSTEM.

3.6.2 Connect signal and power cable

The signal cable enables communication between the indoor and outdoor units. You must first choose the right cable size before preparing it for connection.

Cable Types:

- Indoor Power Cable (if applicable): H05VV-F or H05V2V2-F
- Outdoor Power Cable: H07RN-F

- Signal Cable: H07RN-F

Table: Minimum Cross-Sectional Area able of Power and Signal Cables

| Rated Current of Appliance (A) | Nominal Cross-Sectional Area (mm ²) |
|--------------------------------|---|
| > 3 and ≤ 6 | 0.75 |
| > 6 and ≤ 10 | 1 |
| > 10 and ≤ 16 | 1.5 |
| > 16 and ≤ 25 | 2.5 |
| > 25 and ≤ 32 | 4 |
| > 32 and ≤ 40 | 6 |

1. Prepare the cable for connection:
 - Using wire strippers, strip the rubber jacket from both ends of signal cable to reveal about 40mm (1.57in) of the wires inside.
 - Strip the insulation from the ends of the wires.
 - Using wire crimper, crimp u-type lugs on the ends of the wires.
2. Open front panel of the indoor unit.
3. Using a screwdriver, open the wire box cover on the right side of the unit. This will reveal the terminal block.

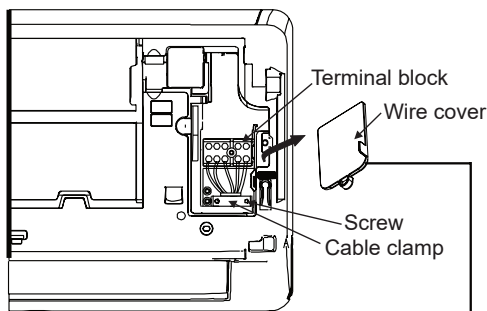

The Wiring Diagram is located on the inside of the indoor unit's wire cover.

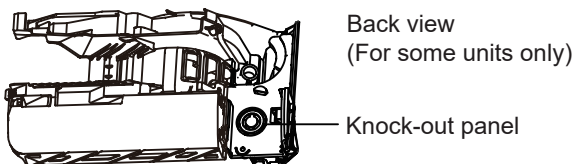

Note:

- For the units with conduit tube to connect the cable, remove the big plastic konck-out panel to create a slot

through which the conduit tube can be installed.

- For the units with five-core cable, remove the middle small plastic knock-out panel to create a slot through which the cable can exit.
 - Use needle nose pliers if the plastic panel is too difficult to remove by hand.
4. Unscrew the cable clamp below the terminal block and place it to the side.
 5. Facing the back of the unit, remove the plastic panel on the bottom left-hand side.
 6. Feed the signal wire through this slot, from the back of the unit to the front.
 7. Facing the front of the unit, match the wire colors with the labels on the terminal block, connect the u-lug and and firmly screw each wire to its corresponding terminal.
 8. After checking to make sure every connection is secure, use the cable clamp to fasten the signal cable to the unit. Screw the cable clamp down tightly.
 9. Replace the wire cover on the front of the unit, and the plastic panel on the back.

NOTE:

- Choose the right cable size

The size of the power supply cable, signal cable, fuse, and switch needed is determined by the maximum current of the unit. The maximum current is indicated on the nameplate located on the side panel of the unit. Refer to this nameplate to choose the right cable, fuse, or switch.

- Take note of fuse specifications

The air conditioner's circuit board (PCB) is designed with a fuse to provide overcurrent protection. The specifications of the fuse are printed on the circuit board, such as: T3.15A/250VAC, T5A/250VAC, etc.

- Pay attention to live wire

While crimping wires, make sure you clearly distinguish the Live ("L") Wire from other wires.

- All wiring must performed strictly in accordance with the wiring diagram located on the back of the indoor units front panel.
- Do not mix up live and null wires.

This is dangerous, and can cause the air conditioning unit to malfunction.

- The wiring connection process may differ slightly between units.

3.7 Wrap piping and cables

Before passing the piping, drain hose, and the signal cable

through the wall hole, you must bundle them together to save space, protect them, and insulate them.

1. Bundle the drain hose, refrigerant pipes, and signal cable according to the picture below:

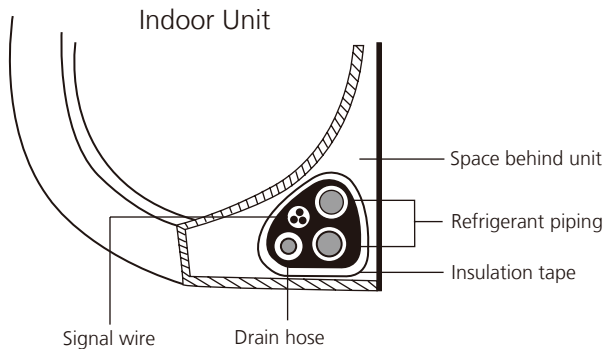

2. Using adhesive vinyl tape, attach the drain hose to the underside of the refrigerant pipes.

3. Using insulation tape, wrap the signal wire, refrigerant pipes, and drain hose tightly together. Double-check that all items are bundled in accordance with the picture above.

NOTE:

- Drain hose must be on bottom

Make sure that the drain hose is at the bottom of the bundle. Putting the drain hose at the top of the bundle can cause the drain pan to overflow, which can lead to fire or water damage.

- Do not intertwine signal cable with other wires

While bundling these items together, do not intertwine or cross the signal cable with any other wiring

- Do not wrap ends of piping

When wrapping the bundle, keep the ends of the piping unwrapped. You need to access them to test for leaks at the end of the installation process.

3.8 Mount indoor unit

3.8.1 If you installed new connective piping to the outdoor unit, do the following:

1. If you have already passed the refrigerant piping through the hole in the wall, proceed to **Prepare refrigerant piping**.
2. Otherwise, double-check that the ends of the refrigerant pipes are sealed to prevent dirt or foreign materials from entering the pipes.
3. Slowly pass the wrapped bundle of refrigerant pipes, drain hose, and signal wire through the hole in the wall.
4. Hook the top of the indoor unit on the upper hook of the mounting plate.

5. Check that unit is hooked firmly on mounting by applying slight pressure to the left and right-hand sides of the unit. The unit should not jiggle or shift.

6. Using even pressure, push down on the bottom half of the unit. Keep pushing down until the unit snaps onto the hooks along the bottom of the mounting plate.

7. Again, check that the unit is firmly mounted by applying slight pressure to the left and the right-hand sides of the unit.

3.8.2 If refrigerant piping is already embedded in the wall, do the following:

1. Hook the top of the indoor unit on the upper hook of the mounting plate.

2. Use the holder in the mounting plate to prop up the unit, giving you enough room to connect the refrigerant piping, signal cable, and drain hose.

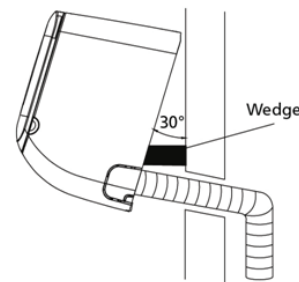

3. Connect drain hose and refrigerant piping (refer to Refrigerant Piping Connection section of this manual for instructions).

4. Keep pipe connection point exposed to perform the leak test (refer to Electrical Checks and Leak Checks section of this manual).

5. After the leak test, wrap the connection point with insulation tape.

6. Remove the bracket or wedge that is propping up the unit.

7. Using even pressure, push down on the bottom half of the unit. Keep pushing down until the unit snaps onto the hooks along the bottom of the mounting plate.

NOTE:

- Unit is adjustable

Keep in mind that the hooks on the mounting plate are smaller than the holes on the back of the unit. If you find that you don't have ample room to connect embedded pipes to the indoor unit, the unit can be adjusted left or right by about 30-50mm (1.25-1.95in), depending on the model.

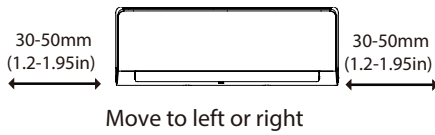

4. Outdoor Unit Installation (Side Discharge Unit)

4.1 Service space for outdoor unit

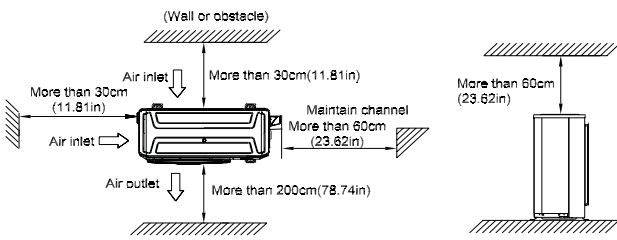

4.2 Bolt pitch

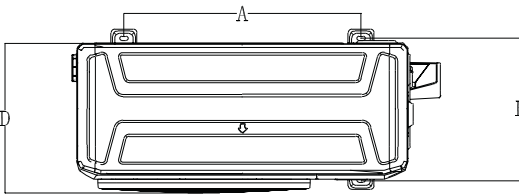

| Model | unit | A | B | D |
|----------------------------|------|-----|-----|-----|
| KSRA21HFRN1 | mm | 430 | 231 | 252 |
| KSRA26HFRN1 KSRA35HFRN1 | mm | 452 | 255 | 270 |
| KSRA53HFRN1 | mm | 452 | 286 | 303 |
| KSRA70HFRN1 | mm | 663 | 354 | 342 |

4.3 Install Outdoor Unit

Fix the outdoor unit with anchor bolts(M10)

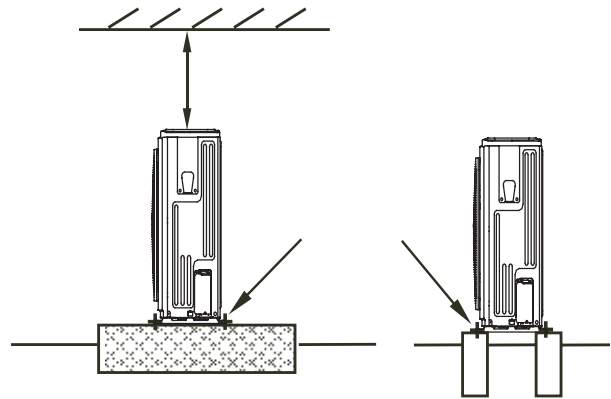

Caution

Since the gravity center of the unit is not at its physical center, so please be careful when lifting it with a sling.

Never hold the inlet of the outdoor unit to prevent it from deforming.

Do not touch the fan with hands or other objects.

Do not lean it more than 45°, and do not lay it sidelong.

Make concrete foundation according to the specifications of the outdoor units.

Fasten the feet of this unit with bolts firmly to prevent it from collapsing in case of earthquake or strong wind.

4.4 Install drain joint

Heat pump units require a drain joint. Before bolting the outdoor unit in place, you must install the drain joint at the bottom of the unit. Note that there are two different types of drain joints depending on the type of outdoor unit.

- If the drain joint comes with a rubber seal (see Fig. A), do the following:

1. Fit the rubber seal on the end of the drain joint that will connect to the outdoor unit.
2. Insert the drain joint into the hole in the base pan of the unit.
3. Rotate the drain joint 90° until it clicks in place facing the front of the unit.
4. Connect a drain hose extension (not included) to the drain joint to redirect water from the unit during heating mode.

- If the drain joint doesn't come with a rubber seal (see Fig. B), do the following:

1. Insert the drain joint into the hole in the base pan of the unit. The drain joint will click in place.

2. Connect a drain hose extension (not included) to the drain joint to redirect water from the unit during heating mode.

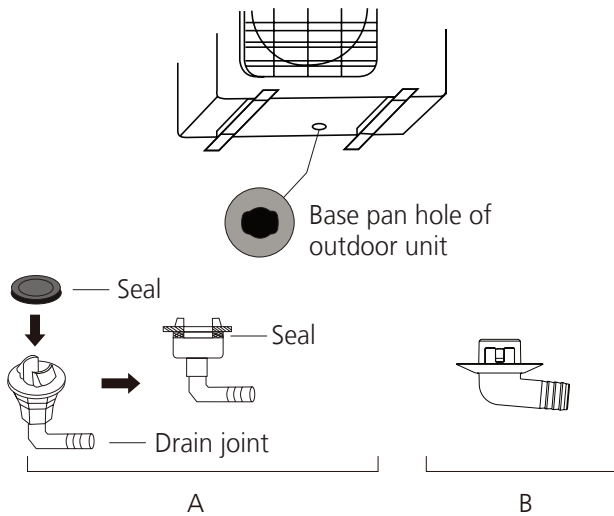

5. Refrigerant Pipe Installation

5.1 Maximum length and drop height

Ensure that the length of the refrigerant pipe, the number of bends, and the drop height between the indoor and outdoor units meets the requirements shown in the following table.

| Models | Max. Length (m) | Max. Elevation (m) |
|----------------|-----------------|--------------------|
| KSGA21~35HFRN1 | 20 | 8 |
| KSGA53~70HFRN1 | 25 | 10 |

caution:

- The capacity test is based on the standard length and the maximum permissible length is based on the system reliability.
- Oil traps

If oil flows back into the outdoor unit's compressor, this might cause liquid compression or deterioration of oil return. Oil traps in the rising gas pipe can prevent this.

-An oil trap should be installed every 6m(20ft) of vertical suction line riser.

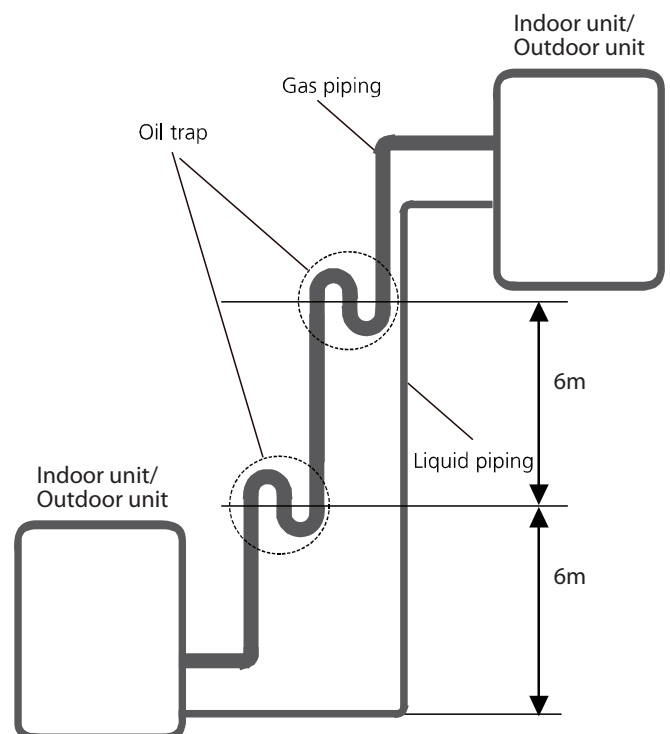

5.2 The procedure of connecting pipes

1. Choose the pipe size according to the specification table.
2. Confirm the cross way of the pipes.
3. Measure the necessary pipe length.
4. Cut the selected pipe with pipe cutter
 - Make the section flat and smooth.

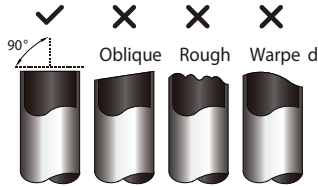

5. Insulate the copper pipe
 - Before test operation, the joint parts should not be heat insulated.
6. Flare the pipe
 - Insert a flare nut into the pipe before flaring the pipe
 - According to the following table to flare the pipe.

| Outer diameter of pipe (inch(mm)) | A (mm/inch) | |
|--------------------------------------|-------------|-----------|
| | Min | Max |
| 1/4" (6.35) | 0.7/0.0275 | 1.3/0.05 |
| 3/8" (9.52) | 1.0/0.04 | 1.6/0.063 |
| 1/2" (12.7) | 1.0/0.04 | 1.8/0.07 |
| 5/8" (15.9) | 2.0/0.078 | 2.2/0.086 |
| 3/4" (19) | 2.0/0.078 | 2.4/0.094 |

- After flared the pipe, the opening part must be seal by end cover or adhesive tape to avoid duct or exogenous impurity come into the pipe.
7. Drill holes if the pipes need to pass the wall.
 8. According to the field condition to bend the pipes so that it can pass the wall smoothly.
 9. Bind and wrap the wire together with the insulated pipe if necessary.
 10. Set the wall conduit
 11. Set the supporter for the pipe.
 12. Locate the pipe and fix it by supporter
 - For horizontal refrigerant pipe, the distance between supporters should not be exceed 1m.
 - For vertical refrigerant pipe, the distance between supporters should not be exceed 1.5m.
 13. Connect the pipe to indoor unit and outdoor unit by using two spanners.

- Be sure to use two spanners and proper torque to fasten the nut, too large torque will damage the bellmouthing, and too small torque may cause leakage. Refer the following table for different pipe connection.

| Pipe Diameter (inch(mm)) | Torque | | Sketch map |
|-----------------------------|-----------------------|--|------------|
| | N.m(lb.ft) | | |
| 1/4" (6.35) | 18~20 (13.3~14.8) | | |
| 3/8" (9.52) | 32~39 (23.6~28.8) | | |
| 1/2" (12.7) | 49~59 (36.1~43.5) | | |
| 5/8" (15.9) | 57~71 (42~52.4) | | |
| 3/4" (19) | 67~101 (49.4~74.5) | | |

| Pipe diameter (inch(mm)) | Flare dimension B (mm/inch) | | Flare shape |
|-----------------------------|-----------------------------|-----------|-------------|
| | Min | Max | |
| 1/4" (6.35) | 8.4/0.33 | 8.7/0.34 | |
| 3/8" (9.52) | 13.2/0.52 | 13.5/0.53 | |
| 1/2" (12.7) | 16.2/0.64 | 16.5/0.65 | |
| 5/8" (15.9) | 19.2/0.76 | 19.7/0.78 | |
| 3/4" (19) | 23.2/0.91 | 23.7/0.93 | |

6. Vacuum Drying and Leakage Checking

6.1 Purpose of vacuum drying

- Eliminating moisture in system to prevent the phenomena of ice-blockage and copper oxidation.
Ice-blockage shall cause abnormal operation of system, while copper oxide shall damage compressor.
- Eliminating the non-condensable gas (air) in system to prevent the components oxidizing, pressure fluctuation and bad heat exchange during the operation of system.

6.2 Selection of vacuum pump

- The ultimate vacuum degree of vacuum pump shall be -756mmHg or above.
- Precision of vacuum pump shall reach 0.02mmHg or above.

6.3 Operation procedure for vacuum drying

Due to different construction environment, two kinds of vacuum drying ways could be chosen, namely ordinary vacuum drying and special vacuum drying.

6.3.1 Ordinary vacuum drying

1. When conduct first vacuum drying, connect pressure gauge to the infusing mouth of gas pipe and liquid pipe, and keep vacuum pump running for 1 hour (vacuum degree of vacuum pump shall be reached -755mmHg).
2. If the vacuum degree of vacuum pump could not reach -755mmHg after 1 hour of drying, it indicates that there is moisture or leakage in pipeline system and need to go on with drying for half an hour.
3. If the vacuum degree of vacuum pump still could not reach -755mmHg after 1.5 hours of drying, check whether there is leakage source.
4. Leakage test: After the vacuum degree reaches -755mmHg, stop vacuum drying and keep the pressure for 1 hour. If the indicator of vacuum gauge does not go up, it is qualified. If going up, it indicates that there is moisture or leak source.

6.3.2 Special vacuum drying

The special vacuum drying method shall be adopted when:

1. Finding moisture during flushing refrigerant pipe.
2. Conducting construction on rainy day, because rain

water might penetrated into pipeline.

3. Construction period is long, and rain water might penetrated into pipeline.
4. Rain water might penetrate into pipeline during construction.

Procedures of special vacuum drying are as follows:

1. Vacuum drying for 1 hour.
2. Vacuum damage, filling nitrogen to reach 0.5Kgf/cm².

Because nitrogen is dry gas, vacuum damage could achieve the effect of vacuum drying, but this method could not achieve drying thoroughly when there is too much moisture. Therefore, special attention shall be drawn to prevent the entering of water and the formation of condensate water.

3. Vacuum drying again for half an hour.

If the pressure reached -755mmHg, start to pressure leakage test. If it cannot reached the value, repeat vacuum damage and vacuum drying again for 1 hour.

4. Leakage test: After the vacuum degree reaches -755mmHg, stop vacuum drying and keep the pressure for 1 hour. If the indicator of vacuum gauge does not go up, it is qualified. If going up, it indicates that there is moisture or leak source.

7. Additional Refrigerant Charge

- After the vacuum drying process is carried out, the additional refrigerant charge process need to be performed.
- The outdoor unit is factory charged with refrigerant. The additional refrigerant charge volume is decided by the diameter and length of the liquid pipe between indoor and outdoor unit. Refer the following formula to calculate the charge volume.

| Diameter of liquid pipe (mm) | Formula |
|------------------------------|------------------------|
| 6.35 | $V=12g/m \times (L-5)$ |
| 9.52 | $V=24g/m \times (L-5)$ |

V: Additional refrigerant charge volume (g).

L : The length of the liquid pipe (m).

Note:

- Refrigerant may only be charged after performed the vacuum drying process.
- Always use gloves and glasses to protect your hands and eyes during the charge work.
- Use electronic scale or fluid infusion apparatus to weight refrigerant to be recharged. Be sure to avoid extra refrigerant charged, it may cause liquid hammer of the compressor or protections.
- Use supplementing flexible pipe to connect refrigerant cylinder, pressure gauge and outdoor unit. And The refrigerant should be charged in liquid state. Before recharging, The air in the flexible pipe and manifold gauge should be exhausted.
- After finished refrigerant recharge process, check whether there is refrigerant leakage at the connection joint part.(Using gas leakage detector or soap water to detect).

8. Electrical and Gas Leak Checks

8.1 Electrical Safety Checks

After installation, confirm that all electrical wiring is installed in accordance with local and national regulations, and according to the Installation Manual.

8.1.1 Before test run

- **Check Grounding Work**

Measure grounding resistance by visual detection and with grounding resistance tester. Grounding resistance must be less than 0.1 Ω.

Note: This may not be required for some locations in the US.

8.1.2 During test run

- **Check for Electrical Leakage**

During the Test Run, use an electroprobe and multimeter to perform a comprehensive electrical leakage test.

If electrical leakage is detected, turn off the unit immediately and call a licensed electrician to find and resolve the cause of the leakage.

Note: This may not be required for some locations in the US.

8.2 Gas Leak Checks

There are two different methods to check for gas leaks.

- **Soap and Water Method**

Using a soft brush, apply soapy water or liquid detergent to all pipe connection points on the indoor unit and outdoor unit. The presence of bubbles indicates a leak.

- **Leak Detector Method**

If using leak detector, refer to the device's operation manual for proper usage instructions.

8.3 After performing gas leak checks

After confirming that the all pipe connection points DO NOT leak, replace the valve cover on the outside unit.

9. Test Operation

9.1 Before test run:

Only perform test run after you have completed the following steps:

- Electrical Safety Checks – Confirm that the unit’s electrical system is safe and operating properly
- Gas Leak Checks – Check all flare nut connections and confirm that the system is not leaking
- Confirm that gas and liquid (high and low pressure) valves are fully open

9.2 Test Run Instructions

You should perform the Test Run for at least 30 minutes.

1. Connect power to the unit.
2. Press the ON/OFF button on the remote controller to turn it on.
3. Press the MODE button to scroll through the following functions, one at a time:
 - COOL – Select lowest possible temperature
 - HEAT – Select highest possible temperature
4. Let each function run for 5 minutes, and perform the following checks:

| List of Checks to Perform | PASS/FALL | |
|--|------------|------------|
| No electrical leakage | | |
| Unit is properly grounded | | |
| All electrical terminals properly covered | | |
| Indoor and outdoor units are solidly installed | | |
| All pipe connection points do not leak | Outdoor(2) | Outdoor(2) |
| Water drains properly from drain hose | | |
| All piping is properly insulated | | |
| Unit performs COOL function properly | | |
| Unit performs HEAT function properly | | |
| Indoor unit louvers rotate properly | | |
| Indoor unit responds to remote controller | | |

5. After the Test Run is successfully completed, and you confirm that all checks points in List of Checks to Perform have PASSED, do the following:

- Using remote control, return unit to normal operating temperature.
- Using insulation tape, wrap the indoor refrigerant pipe connections that you left uncovered during the indoor unit installation process.

9.3 If ambient temperature is below 16°C (60°F)

You can’t use the remote controller to turn on the COOL function when the ambient temperature is below 16°C. In this instance, you can use the MANUAL CONTROL button to test the COOL function.

1. Lift the front panel of the indoor unit, and raise it until it clicks in place.
2. The MANUAL CONTROL button is located on the right-hand side of the display box. Press it two times to select the COOL function.
3. Perform Test Run as normal.

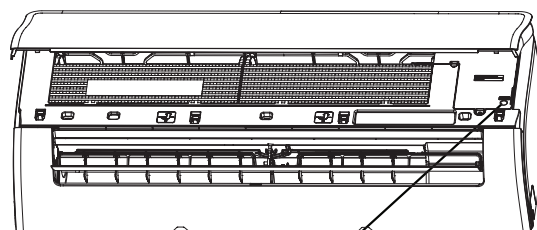

Manual control button

Notes

Notes

 **KENTATSU**

IS THE TRADEMARK OF
KENTATSU DENKI, JAPAN